

**PRODUCT  
NOVELTIES**

 intra lighting

INDEX

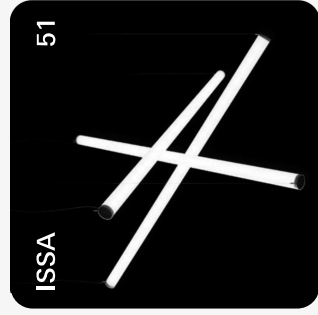
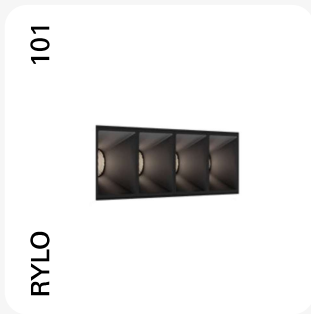
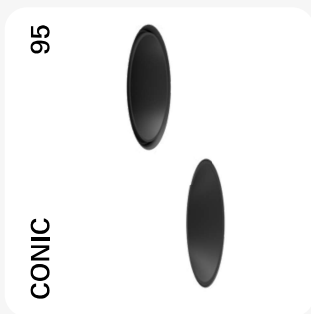
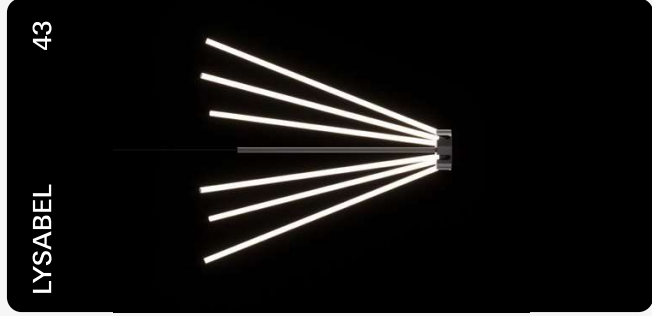
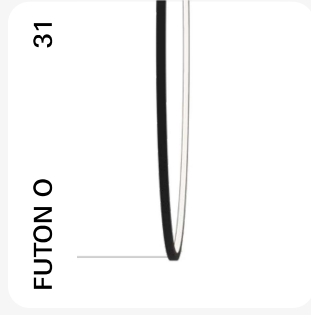
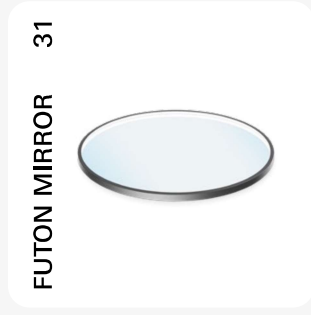
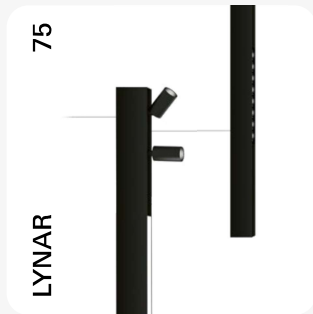
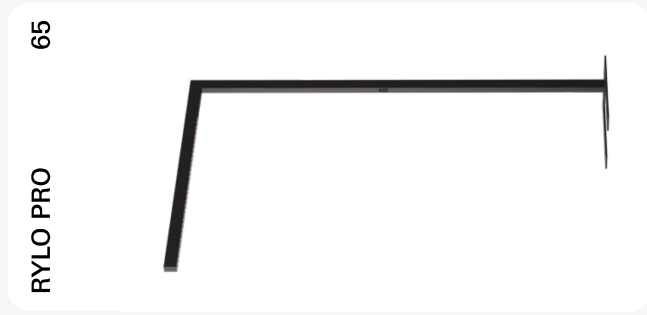
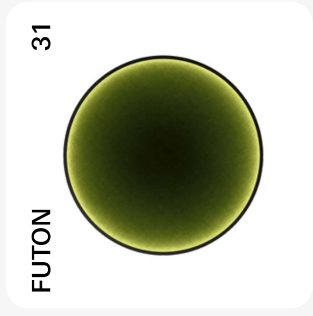
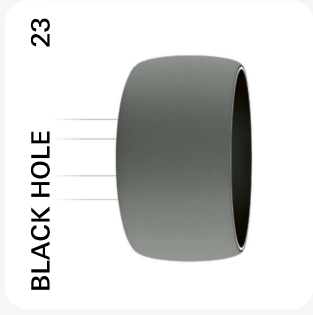

# We care.

## For people and for the planet.

We have always been ahead of time. We lived and acted sustainably before sustainability became synonymous with responsible behaviour towards the environment and people. Concern about what kind of world we will leave to our children has always been present in everything we do. We were not guided by regulations; we were guided by conscience and consciousness.

### KEY AREAS WE WILL FOCUS ON

## 01

### PRODUCTS

#### Circular and human-friendly products

- Products supporting people's well-being
- Responsible use of materials
- Material and data transparency
- Energy-efficient products
- Repairability, prolonging products life
- Design for disassembly
- High recyclability

## 02

### SOLUTIONS

#### Healthy living and improved well-being with light

- Human-centric lighting solutions
- Supporting health, positive feelings and motivation
- All-in-one acoustics solutions
- Smart use of artificial and natural light
- Connection with different LMS systems

## 03

### COMPANY

#### Sustainable and ethical company

- Becoming a net zero company
- High ethical standards
- Environmental-friendly production
- Responsible supplier choice
- A caring employer
- Care for local community

## Our initiatives

100% green energy\*  
2.000+ trees planted  
rainwater harvesting for watering green areas

75% in 2022 | 100% by 2024

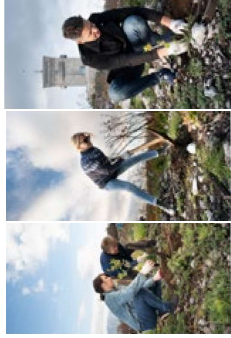

We are pleased for the purchase of 2023 seedlings. Now, we will invest 500 hours of our work in a reforestation action and will support the project long-term.



We support culture, sports, health and social initiatives in our local community.



We are surrounded by green areas. We planted 80 fruit and leaf trees of local varieties and more than 1000 plants.



We have our own solar power plant and heat pump. Renewable energy sources for electricity: 20% in 2021



We breathe new life in old degraded buildings. We reuse a lot of the construction materials from the demolition work.

OUR WORLD

# Present globally connected locally

Our company, established in 1989, is a global provider of smart lighting solutions. We are present worldwide but always closely connected to the local environment. As one of the most important players in the lighting market, we strive to contribute to the world's well-being. We work closely with architects, lighting designers, engineers and interior designers around the globe to co-create engaging lighting solutions and foremost vibrant spaces.

## ✦ Headquarters

Slovenia, Šempeter pri Gorici

## ● Offices

Croatia - Zagreb  
Italy - Milan  
Netherlands - Leerdam  
Serbia - Belgrade  
Slovenia - Ljubljana  
UAE - Dubai  
USA - New York

## ● Production plants

Slovenia, Šempeter pri Gorici  
Croatia, Čazma  
Serbia, Donji Milanovac  
USA, Pennsylvania, Treviso (coming soon)

## ● Presence

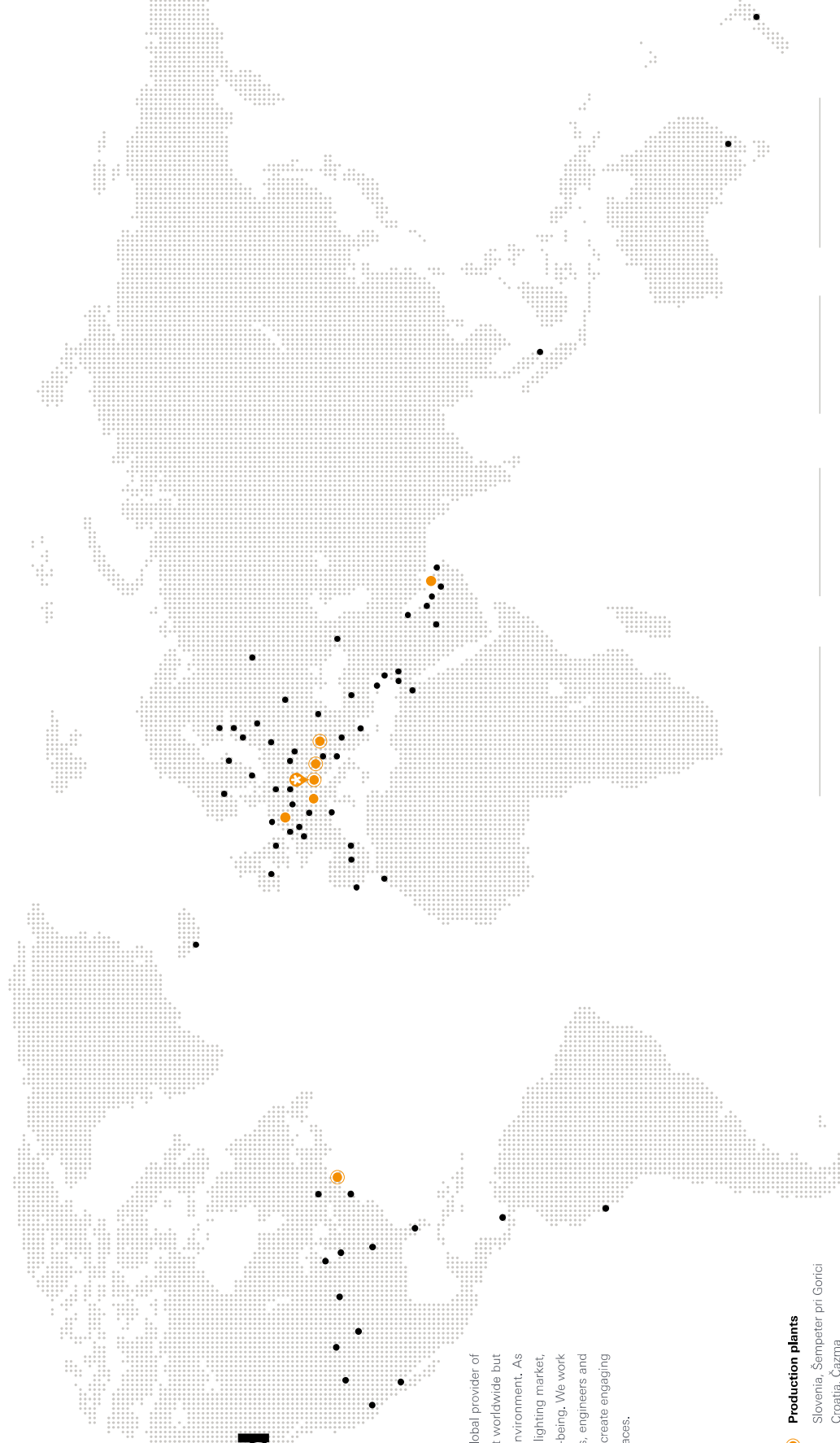

400+

employees

68

countries

34+

years of experience

37,6

mio EUR turnover in 2022





# Made in Europe

## State of the art production

With a new production process, we have reduced energy consumption, raw materials, natural resources and waste. We introduced an automated vertical storage system, a modern powder coating system and an automated guided vehicle for flexible internal logistics.



Solar panels generate enough energy to run the factory and HQ autonomously.



Modern powder coating system with low water and energy consumption, pre-treatment tunnel with passivation (corrosion protection), and automated powder application with a recovery system.



Safe and comfortable working environment

7 24 ISO

year warranty thousand m<sup>2</sup> certified productions

## Quality in every detail

Our products are thoughtfully designed, manufactured and tested in order to ensure reliable operation throughout their life span, strongly limit the environmental impact and co-create pleasant living conditions. Quality is one of our highest priorities and a way of life.



Automated guided vehicle for flexible internal logistics

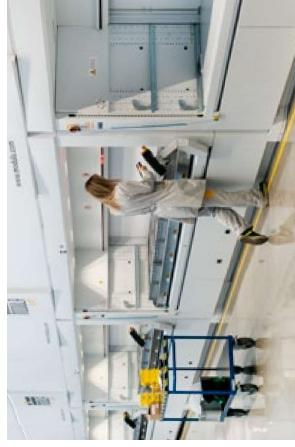

Automated vertical storage system



Robotic Welding Systems



Turn-mill center with collaborative robot



All the products are 100% tested in our own lab, one of the biggest in Europe.

# Just a click away

Visit our website to comprehend the portfolio quickly, discover the novelties, and find the product you are looking for. There are different ways to find inspiration for your projects. The user experience is simple, fast and intuitive. Make a click!

**Products overview**

**Technical overview of the product family**

**Quick ship products**

**Explore the detailed product presentation**

**Get the product code and documentation quickly through configurator**

**Find the product in less than a minute!**

There are many ways to find a product. Search visually by family or models. Or technically by filters, defining a specific feature or installation type. There is also a Quick ship filter available.

## Intra Configurator

Intra Configurator is an easy, fast and accurate tool, with simple feature selection. Its role is to prevent all the mistakes that could be done while planning. Every product also gets its own **technical card and all the necessary documentation downloads.**

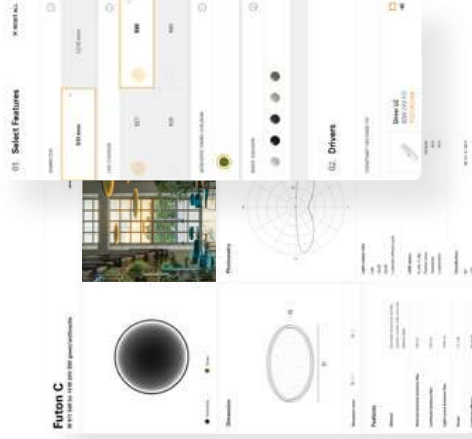

## Intra Constructor PRO

### Work smarter. Be faster.

There has never been an easier way to design your next lighting system. Intra Constructor PRO enables quick, simple and precise selection of lighting modules that can be personalized to fit best in your interior design. Every design is unique and no piece is forgotten

100% ~~0~~

accurate

forgotten parts



## Interactive product presentations

Get all the product presentations in only one download. Browse through them offline, quickly and easily, the complete portfolio, new products included, is presented.

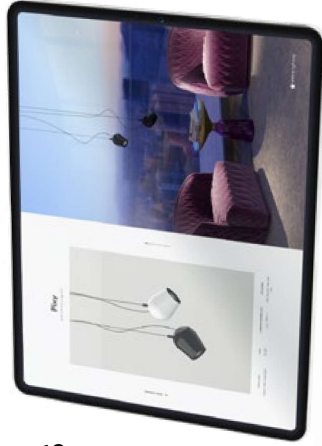

## Architecture and design platforms

We are, where you are. Get inspired, create mood boards and explore our products and projects.

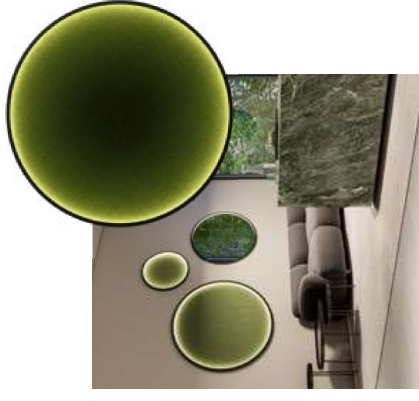

archiproducts

ARCHITONIC

bimobject

LOVE THAT DESIGN

Pinterest



## Our lighting guides

Equip yourself with precious knowLEDge about lighting in different project types and its impact on people's well-being. Our lighting guides are available in interactive PDF, so they'll support your work also offline.

## Bim

### A game changer for the construction industry.

BIM offers an intelligent 3D process to efficiently plan, design and construct throughout the building life cycle, to support and manage your projects easily. A wide range of our products is available in 3D BIM at BIM object library.

Our products are available in the following formats:

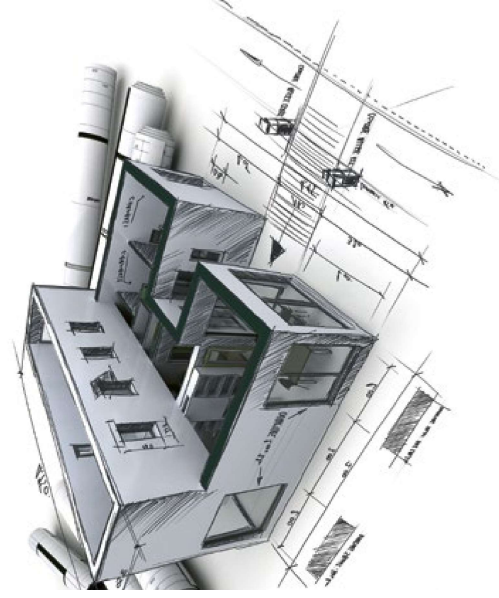





# Pixy

Authentically magnetic

**Move your table, Pixy will follow**

Pixy is never fixed. It is always flexible. Which makes it the perfect choice for restaurants and bars where moving tables is a daily routine. With a small carbon rod and a magnet, you can instantly move and redirect the light without using the ladder. We think that Pixy is nicer when grouped. Combine composition over and over again.

**Se sposti il tavolo, Pixy lo segue**

Pixy non si fissa. È sempre flessibile. È la soluzione perfetta per ristoranti e bar dove tutti i giorni si devono spostare i tavoli. Non serve la scala, in un attimo puoi spostare e orientare la luce con una tige in carbonio e un magnete. Per noi Pixy dà il massimo quando è in gruppo. Si può comporre e ricombinare a piacere.

**Premaknite svojo mizo. Pixy vam bo sledila**

Pixy ni nikoli fiksna. Je povsem fleksibilna in kot taka odlična izbira za restavracije in bare, kjer je premikanje miz vsakodnevna rutina. Z majhno karbonsko palčko in magnetom lahko svetlobo v trenutku premaknete in preusmerite brez uporabe lestve. Menimo, da je Pixy lepša v kompoziciji, ki jo lahko kar naprej spreminjate.

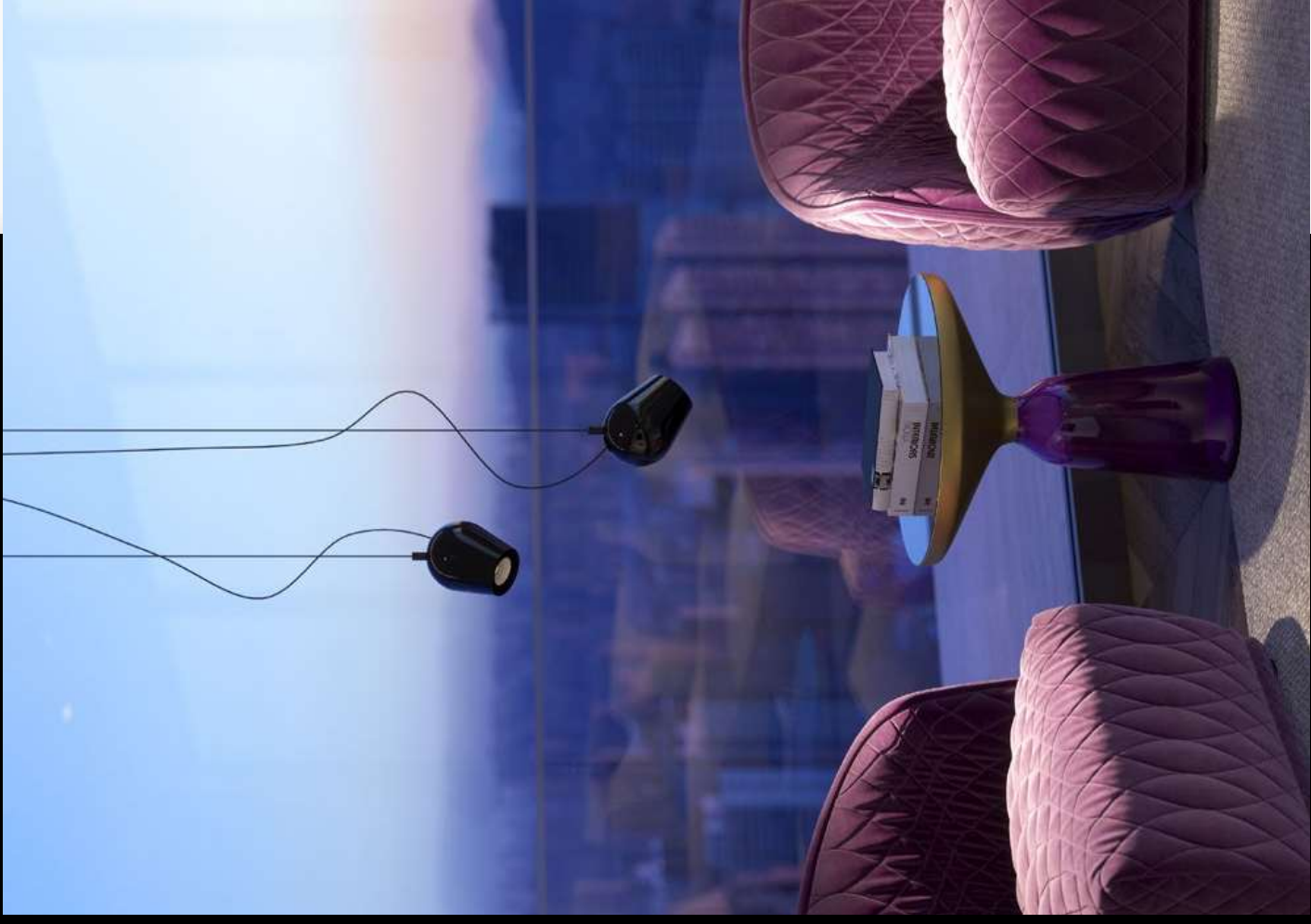



Private residence / Interior design: Notio / Visualization: Duaviz

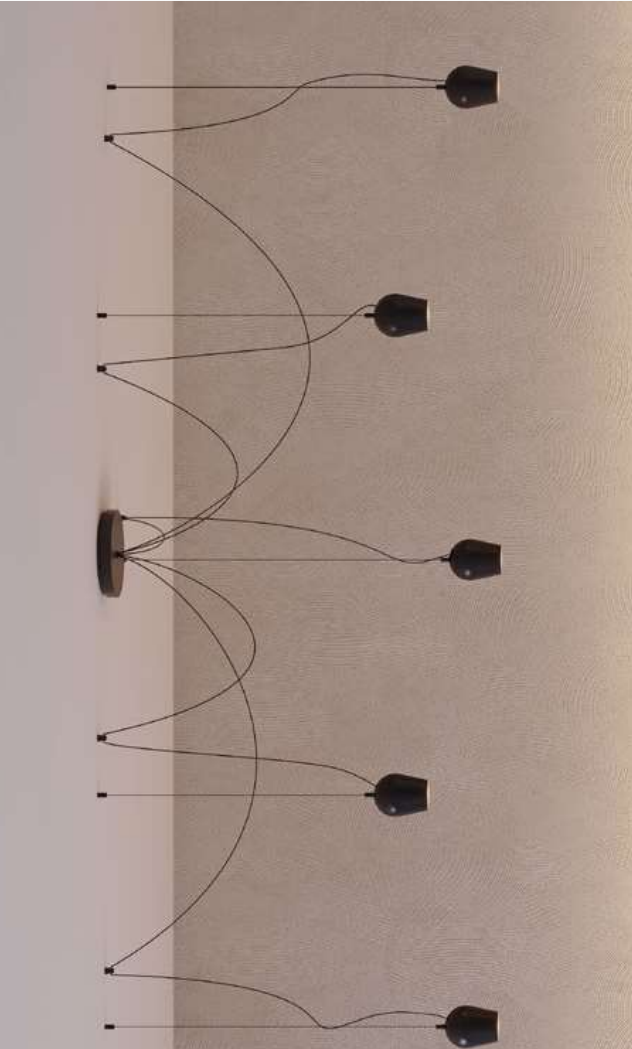

Bar B / Visualization: Render Ateller





Vinarija Tarpos, Arandelovac, Srbija / Architecture: AteljeAL, Beograd / Photography: Miroslav Martinović  
 Private residence, Croatia / Interior design: Notio / Visualization: Vividforge  
 Private residence / Interior design: Notio / Visualization: Vividforge

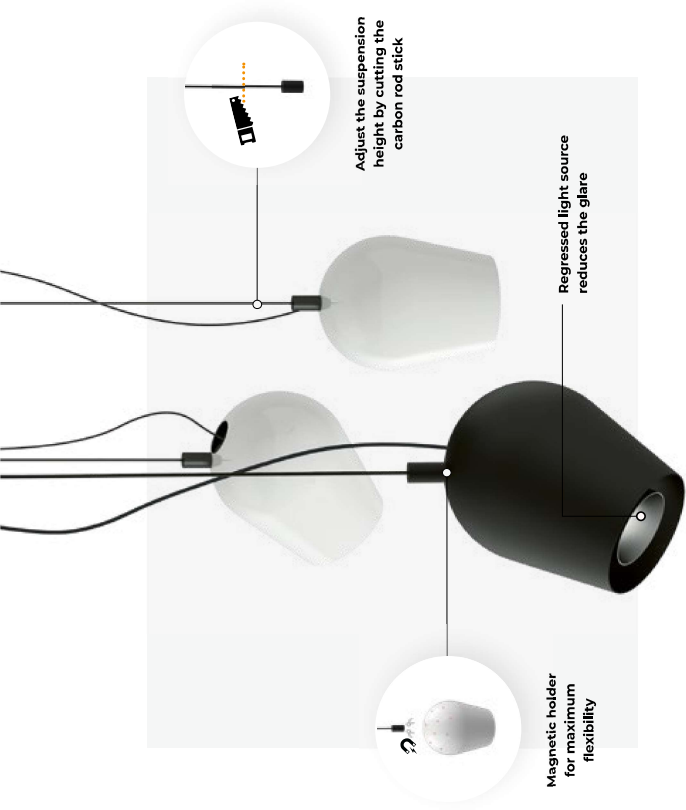

MAIN FEATURES



**Step-less orientation**

The magnet allows step-less orientation. This gives you freedom when moving and redirecting the light to the desired position. It comes very useful in situations where moving furniture is a daily routine.

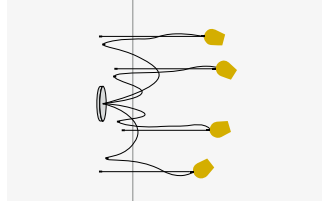
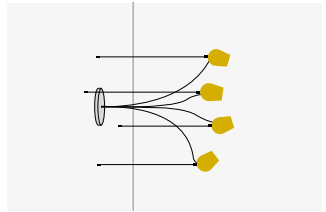

**Combine your favourite composition**

With cluster installation you can combine up to seven spots. Cables can become part of the design and remote power-in position will no longer be a problem.



**Aesthetic solution for concrete ceilings**

The driver is integrated into the ceiling cup, so it is appropriate for installing it when you can't have a remote driver. Thanks to the magnets, Pixy can be simply adjusted to the desired direction.



**One bar, 3 or 5 spots**

Why having many single ceiling cups when you can have only one aesthetic bar with integrated driver? 3 or 5 spots can be flexibly rotated and dimmed.

# Pixy

## Technical Overview



	<b>S</b> Suspended	<b>C/W</b> Ceiling / Wall	<b>C/W D</b> Ceiling / Wall with integrated driver	<b>C/W-BAR 3</b> Ceiling / Wall with integrated driver	<b>C/W-BAR 5</b> Ceiling / Wall with integrated driver
<b>Beam angle</b>	30°, 50°	± 58° / 360°	30°, 50°	30°, 50°	± 58° / 360°
<b>Orientation</b>	± 95° / 360°	± 58° / 360°	± 58° / 360°	± 58° / 360°	± 58° / 360°
<b>Luminaire luminous flux</b>	1150 - 1550 lm	1150 - 1550 lm	1150 - 1550 lm	3x 1150 - 1550 lm	5x 1150 - 1550 lm
<b>LED colour</b>	927, 930, 935, 940	927, 930, 935, 940	927, 930, 935, 940	927, 930, 935, 940	927, 930, 935, 940
<b>Driver</b>	Casambi, DALI, FO	Casambi, DALI, FO	Casambi, DALI, FO	Casambi, DALI, FO	Casambi, DALI, FO
<b>Driver position</b>	Ceiling cup / Remote	Remote	Ceiling cup	Ceiling bar	Ceiling bar
<b>Dimensions</b>	SH (mm): 500 - 2000				

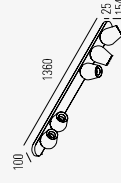
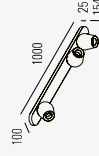
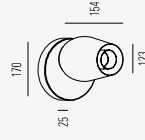
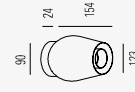
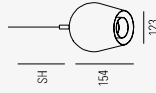

Standard: **B** **D** **A** **C** Special colours:



**Light source:** High-power COB LED, CRI>90, MacAdam's2, 50,000h L90 B10 at 35°C. **Optic:** Highly efficient with uniform distribution, metallized polycarbonate with lacquer finish. **Body:** Steel-sheet, powder coated. **Ceiling cup:** Ceiling cup with or without driver or ceiling bar with integrated driver must be ordered separately. **Control gear:** Constant current driver (order separately). In the Pixy C Bar integrated highly-efficient driver with fixed output (FO) or dimmable (DALI-TD, Casambi). **Power supply:** 250 - 450mA / 230V 50Hz.

**Sorgente:** COB LED High-power, CRI>90, MacAdam's2, 50,000h, L90 B10 a 35°C. **Optica:** Ottica ad alta efficienza con distribuzione uniforme, policarbonato metallizzato tramite laccatura. **Corpo:** Lamiera d'acciaio, verniciatura a polvere. **Rosone:** Rosone con o senza alimentatore da ordinare separatamente o sistema C BAR con alimentatore integrato da ordinare separatamente. **Alimentazione:** Alimentatore a corrente costante (ordinare separatamente). Nella Pixy C Bar è compreso alimentatore ON-OFF (FO) o dimmerabile (DALI-TD, Casambi). **Alimentatore:** 250 - 450mA / 230V 50Hz.



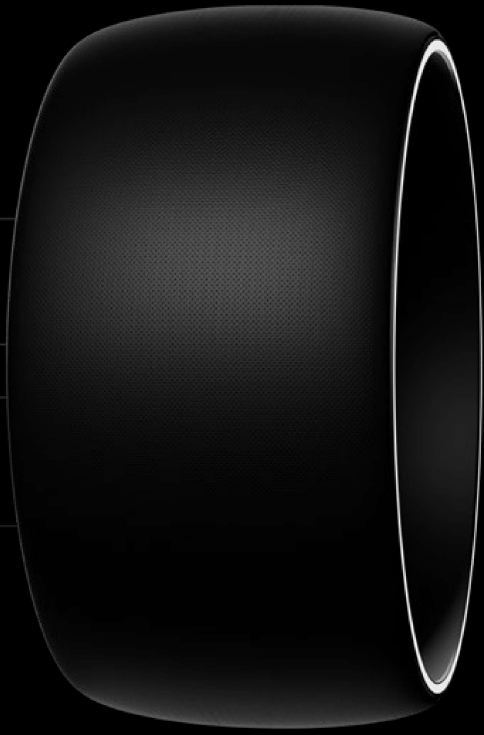

# Black Hole

Extreme phenomenon

## Its perfection absorbs you

This is a story of how the light found the way out of the black hole to enlighten your space. Black hole is a perfect luminaire for all your galaxies – home, office, hospitality. Because of its size and distinct look it has absolutely no chance to stay invisible.

It is multifunctional. It offers different possibilities of illumination. The acoustic surface reduces noise and improves speech audibility. With its integrated Bluetooth loudspeaker, you can listen to your favourite music, and its sophisticated design brings a touch of luxury to your space. Last but not least, the atmosphere it creates might help you find the way out whenever you feel stuck in a black hole.

## La perfezione ti cattura

Black hole narra di come la luce trova la strada per uscire da un buco nero e illumina i tuoi spazi. È la soluzione perfetta per le galassie della tua vita: casa, ufficio, alberghi. Non rischia davvero di passare inosservata, sia per le dimensioni che per il design esclusivo.

È multifunzionale, dispone di diverse modalità di illuminazione. La superficie acustica abbatte il rumore e migliora l'intelligibilità del parlato. La tua musica viene diffusa dall'altoparlante bluetooth integrato e i tuoi spazi vengono resi sonuosi dal sofisticato design. Ma, soprattutto, l'atmosfera che si crea ti aiuta a trovare la tua personale via d'uscita ogni volta che ti senti bloccato in un buco nero.

## Njena popolnost vas posrka

To je zgodba o tem, kako je svetloba našla pot iz črne luknje in razsvetlila vaš prostor. Črna luknja je popolna svetilka za vse vaše galaksije – dom, pisarno, gostinstvo. Zaradi svoje velikosti in izrazitega videza jo je nemogoče prezreti.

Je večnamenska. Ponuja različne možnosti osvetlitve. Akustična površina zmanjšuje hrup in izboljšuje sluhnost govora. Preko vgrajenega zvočnika s tehnologijo Bluetooth lahko poslušate svojo najljubšo glasbo, njena elegantna oblika pa v vaš prostor vselja njene pridelih razkošja. Nena zadnje, vzdušje, ki ga ustvarja, vam lahko pomaga najti izhod, ko se počutite, kot da ste obleščali v črni luknji.







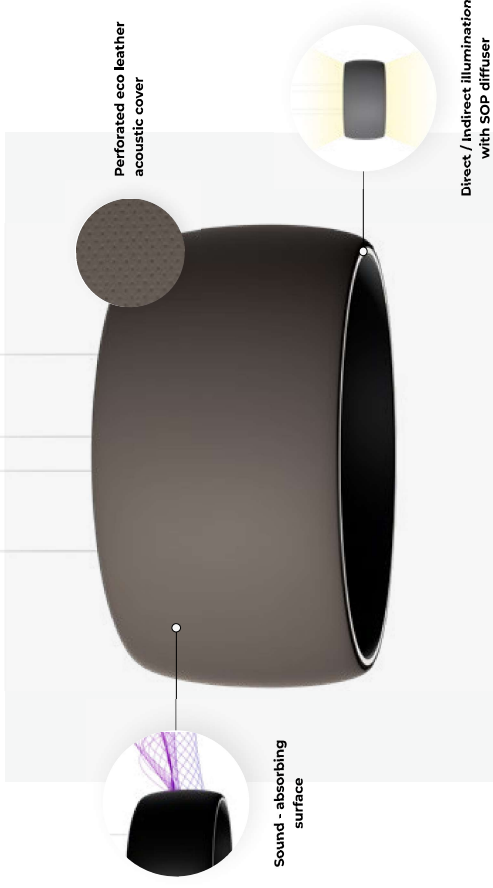

**MAIN FEATURES**

**A touch of luxury**

Black Hole is different from other luminaires even at a glance, always adding a touch of luxury to the space. Its soft round form is ageless.

**Noise reduction**

The noise level in a space has an impact on the well-being. The big acoustic surface of Black Hole reduces the noise pollution in the space and improves the acoustics.

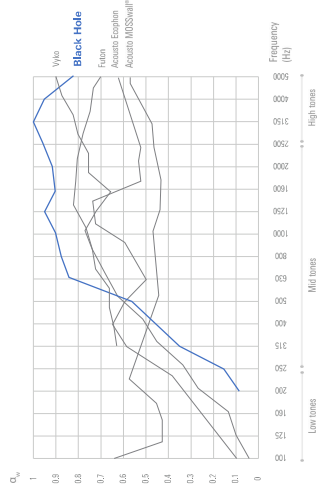
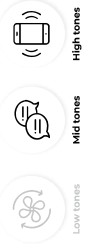



## Dome-shaped black interior

It creates the essence of Black Hole, where you lose the sense of the product deepness. Direct / indirect illumination can be switched or dimmed separately, making this luminaire a perfect fit for your changing needs.

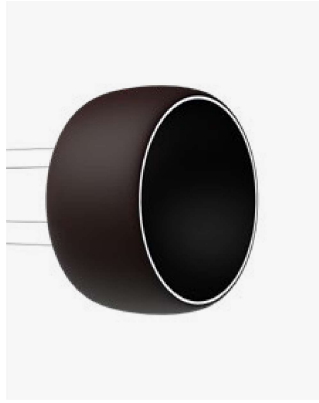

## Bluetooth Sound System

With the use of wireless Bluetooth technology, you can connect smartphones, computers, or tablets and enjoy your favourite music with a built-in speakers system.

### FEATURES:

Output power: 4x30W | Peak power: 4x50W | Dynamic frequency response range: 100 Hz - 15000 Hz +/- 3 dB, 80 Hz - 20000 Hz +/- 5 dB | Bluetooth version: 5.1



# Black Hole

Technical Overview



## TECH. SPECS

<b>LUMINAIRE LUMINOUS FLUX</b>	4400 - 4800 lm	<b>LIGHT DISTRIBUTION</b>	Direct 50% / Indirect 50%	<b>LED COLOUR</b>	927, 930, 940	<b>DRIVER</b>	Casambi, DALI, TD
<b>MATERIAL</b>	Perforated eco leather	<b>SOUND ABSORBING SURFACE</b>	1 m <sup>2</sup>	<b>SUSPENSION HEIGHT</b>	1500, 3000, 5000 mm		

## MATERIALS

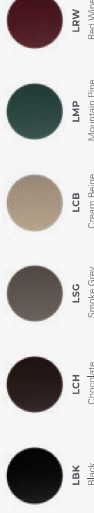

**Light source:** High-flux LED strip, CRI>90, MacAdams2, 50000h L90 B10 at 35°C. **Optic:** Satin opal polycarbonate diffuser (SOP). **Body:** Aluminium dome, powder coated, with faux leather upholstery.

**Ceiling cup:** For suspended versions, the ceiling cup and suspension set must be ordered separately. Find out more on the technical pages or online product configurator. **Control gear:** Integrated highly-efficient driver with fixed output (FO-DS) or dimmable (DALI-DS, TD, Casambi) - separate switching. **Power supply:** 230V 50Hz.

**Sorgente:** Strip LED High-flux, CRI>90, MacAdams2, 50.000h L90 B10 a 35°C. **Optica:** Diffusore in policarbonato opale satinato (SOP). **Corpo:** Cupola in alluminio, verniciata a polvere, con rivestimento in ecopelle.

**Rosone:** Perla versioni a sospensione, il rosone e il kit di sospensione deve essere ordinato separatamente. Maggiori informazioni nelle pagine relative alle caratteristiche tecniche o sul configuratore del prodotto online. **Alimentazione:** Alimentatore integrato on/off ad alta efficienza (FO-DS) o dimmerabile (DALI-DS, TD, Casambi) - accensione separata. **Alimentatore:** TD, Casambi) - accensione separata. **Alimentatore:** 230V 50Hz.

**Svetlobni vir:** Visoko svetiljen LED trak, CRI>90, barvno odstopanje MacAdams2, 50.000h L90 B10 na 35 °C. **Optika:** Satiniran opalni polikarbonatni difuzor (SOP). **Ovitje:** Aluminijasta kupola, prašno barvana, Obod iz umetnega usnja. **Stropna rozeta:** Za visoke verzije se rozete in vešala naročajo posebej. Več na straneh s tehnično vsebino ali v spletnem konfiguratorju. **Napajalniki:** Integriran visoko učinkovit LED konverter s konstantnim tokom (FO-DS) ali regulacijskim izhodom (DALI-DS, TD, Casambi) - ločeno prižigavanje. **Napajanje:** 230 V 50 Hz.





# Futon

Night's silence

## Say goodbye to noise

It's a lifesaver for all those projects where you want to combine unique ambient lighting, functionality of acoustics and trendy colours.

Alone or in a creative composition, Futon gives its best when improving speech audibility, and creates an appealing ambience thanks to the light source that illuminates the acoustic fabric.

## Addio al rumore

Si tratta di una vera ancora di salvezza per tutti quei progetti in cui si desidera abbinare a un'illuminazione particolare dell'ambiente la funzionalità dell'acustica e colori di tendenza.

Da solo o all'interno di una composizione creativa, Futon esprime il meglio di sé migliorando la comprensione del linguaggio e creando al tempo stesso un'atmosfera intrigante grazie alla sorgente luminosa che rischiarerà il tessuto fonoassorbente.

## Poslovitve se od hrupa

Futon je dobra izbira za projekte, pri katerih želimo kombinirati ambienttalno svetlobo, akustiko in modne barve.

Samostojno ali v ustvarjalnih kompozicijah, Kadar koli želimo izboljšati silsnost govora, hkrati pa s svetlobo, ki osvetljuje akustično tkano, ustvariti prijeten ambient, se Futon resnično dobro odreže.





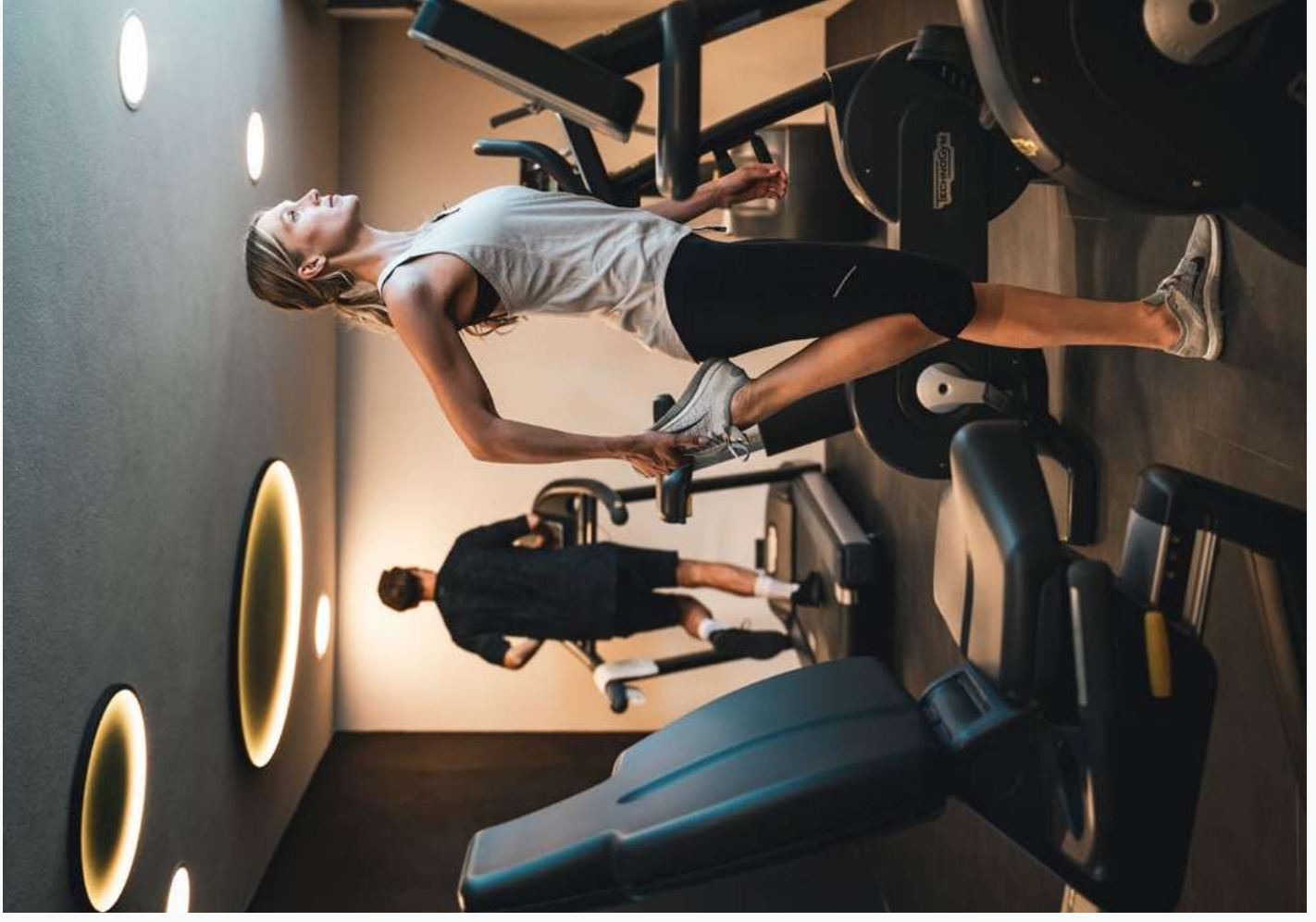









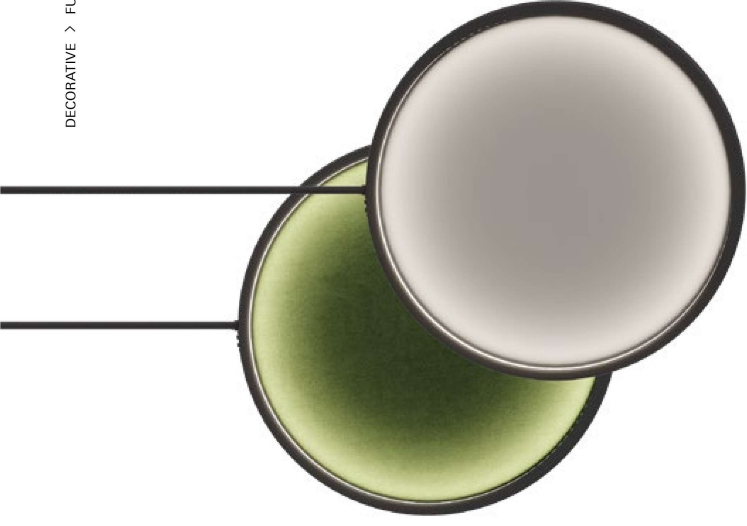

## Make it double for a double effect

There will be no acoustic trouble if you choose Futon double. One suspension, but double acoustic fibre or opal diffuser, double light source (on both sides) and most of all double effect.

## A mirror? A lamp? Both!

Futon Mirror is a mirror and a lamp all-in-one. The lateral light will illuminate your face and clothes in the best way without any shadows or colour deviations.



## No steam on the mirror surface

This version of Futon is ideal for bathrooms, especially those with inadequate ventilation. A special mirror demister warms up the mirror at 30-35°C, a perfect temperature to prevent the mirror surface from the condensation of steam.

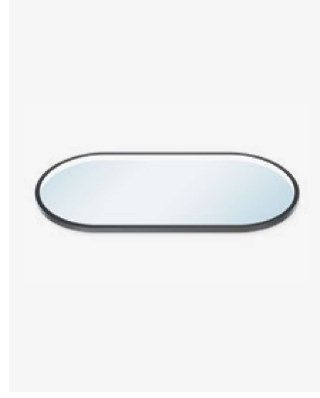

Thin performer

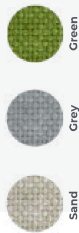

## MAIN FEATURES

### Rich in light effect

The hidden light source illuminates the sound absorbing acoustic panel from the inner edge. Subsiding evenly, it creates a rich glow effect on the fabric.



### Maximum acoustic comfort

Futon enables effective soundproofing and sound absorbing in all areas with higher frequencies.

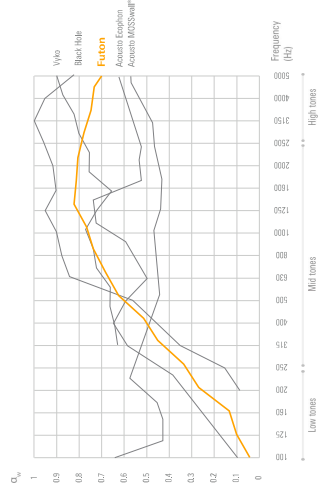
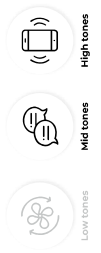

# Futron

## Technical Overview

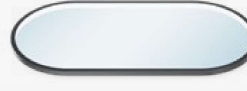
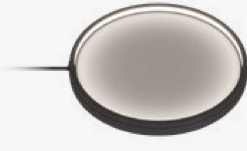

	<b>C/W Acoustic</b> Ceiling / Wall	<b>S Acoustic</b> Suspended	<b>SD Acoustic</b> Suspended double	<b>SD Opal</b> Suspended double	<b>Mirror Round</b> With or without a heater	<b>Mirror Oval</b> With or without a heater	<b>Mirror Rectangular</b> With or without a heater
<b>Luminaire luminous flux</b>	510 - 1450 lm	510 - 1450 lm	1000 - 1400 lm	3200 - 5150 lm	1650 - 2650 lm	2700 - 2950 lm	2550 - 3900 lm
<b>Optic</b>	SOP	SOP	SOP	SOP	SOP	SOP	SOP
<b>LED colour</b>	927, 930, 940	927, 930, 940	927, 930, 940	927, 930, 940	927, 930, 940	927, 930, 940	927, 930, 940
<b>Driver</b>	Casambi, DALI, FO	Casambi, DALI, FO	Casambi, DALI, FO	Casambi, DALI, FO	Casambi, DALI, FO	Casambi, DALI, FO	Casambi, DALI, FO
<b>Driver position</b>	Remote	Ceiling cup / Remote	Ceiling cup / Remote	Ceiling cup / Remote	Remote	Remote	Remote
<b>Material</b>	RecycLED ISOPET acoustic panel	RecycLED ISOPET acoustic panel	RecycLED ISOPET acoustic panel	SOP (Satin opal diffuser)	Mirror	Mirror	Mirror
<b>IP Protection</b>	IP40	IP40	IP40	IP40	IP44	IP44	IP44
<b>Sound absorbing surface</b>	0,3 / 1,2 m <sup>2</sup>	0,6 / 2,4 m <sup>2</sup>	0,6 m <sup>2</sup>	-	-	-	-
<b>Colour</b>	<b>B</b> <b>D</b> <b>J</b>	<b>B</b> <b>D</b> <b>J</b>	<b>B</b> <b>D</b> <b>J</b>	<b>B</b> <b>D</b> <b>J</b>	<b>B</b> <b>D</b> <b>H</b> <b>F</b> <b>Y</b>	<b>B</b> <b>D</b> <b>H</b> <b>F</b> <b>Y</b>	<b>B</b> <b>D</b> <b>H</b> <b>F</b> <b>Y</b>
<b>Textile colour</b>							

	<b>C/W Acoustic</b> Ceiling / Wall	<b>S Acoustic</b> Suspended	<b>SD Acoustic</b> Suspended double	<b>SD Opal</b> Suspended double	<b>Mirror Round</b> With or without a heater	<b>Mirror Oval</b> With or without a heater	<b>Mirror Rectangular</b> With or without a heater
<b>Dimensions</b>	D (mm): 611, 1216 SH (mm): 1500, 3000, 5000	D (mm): 611, 1216 SH (mm): 1500, 3000, 5000	D (mm): 611, 899 SH Rod (mm): 500 - 2000 SH Suspension set (mm): 1500, 3000, 5000	D (mm): 611, 899 SH Rod (mm): 500 - 2000 SH Suspension set (mm): 1500, 3000, 5000	D (mm): 611, 900	D (mm): 611, 1217	H (mm): 906, 1506
<b>Diagram 1</b>							

≥ 90 %

**Light source:** High-flux LED strip, CRI>90, MacAdams2, 500000h L90 B10 at 35°C.  
**Optic:** Satin opal polycarbonate diffuser (SOP). **Body:** Extruded aluminium profile, powder coated with acoustic panel or satin opal diffuser or mirror plate. **Ceiling cup:** Ceiling cup with or without driver must be ordered separately. **Control gear:** Constant voltage driver - order separately. **Power supply:** 24V DC.

**Sorgente:** Strip LED High-flux, CRI>90, MacAdams2, 50,000h L90 B10 a 35°C.  
**Optica:** Diffusore in polcarbonato opale satinato (SOP). **Corpo:** Profilo in alluminio estruso, verniciatura a polvere con pannello acustico o schermo opale satinato o specchio. **Rosone:** Rosone con o senza alimentatore da ordinare separatamente. **Alimentazione:** Alimentatore a tensione costante - ordinare separatamente. **Alimentatore:** 24V DC.

**Svetlobni vir:** Visoko svetiljen LED trak, CRI>90, barvno odstopanje MacAdams2, 50,000h L90 B10 na 35 °C. **Optika:** Satiniran opalni polikarbonatni difuzor (SOP). **Ohlajše:** Ekstrudiran profil iz aluminija, prašno barvan s centralno ploščo iz akustičnega materiala, satiranega opalnega difuzorja ali zrcalom. **Stropna rozeta:** Stropno rozeto z ali brez LED konverterja je treba naročiti ločeno. **Napajalnik:** LED konverter s konstantno napetostjo - ločeno naročanje. **Napajanje:** 24V DC.

For the latest product data please refer to the web page. For accessories and colour selection use the online product configurator.

41 [intra-lighting.com/#futon](http://intra-lighting.com/#futon)
42



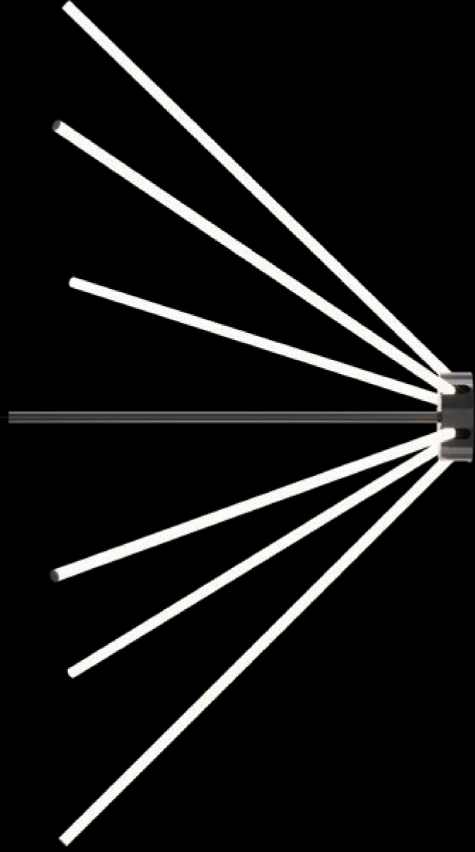

# Lysabel

A saber of light

**Finally, you can have the lightsaber you always wanted**

Lysabel will always bring a touch of sophistication to your space, whether vertical, horizontal, inclined, single or grouped in different creative compositions. It is a slender homogeneously lit tube without shadows. Its look is clean, minimalist and refined, with every last detail carefully crafted. Looks fragile, but it's not. Its force is versatile – for the power of light and of appearance.

**Finalmente potrai avere la spada laser che hai sempre desiderato**

Lysabel riesce a donare un tocco di raffinatezza agli ambienti, sia in posizione verticale che orizzontale o inclinata, da sola o in gruppo, per dare origine a diverse composizioni che spazzano creativamente. Si tratta di un tubo sottile illuminato in maniera uniforme, senza ombre. Le sue linee sono pulite, minimaliste ed eleganti: ogni suo minimo dettaglio nasce da un'attenta lavorazione. Può sembrare fragile, ma non lo è. La sua forza consiste nella versatilità: una fusione tra potere ed estetica della luce.

**Končno si lahko priskrbite svetlobni meč, ki ste si ga vedno želeli**

Lysabel bo v vaš prostor vedno prinesla kaneček prefinjenosti, naj bo v navpični, vodoravni, nagnjeni postavitvi, samostojna ali v različnih kreativnih kompozicijah. Je vitka homogeno osvetljena cev brez senc. Njen videz je čist, minimalističen in prefinjen ter vključuje skrbno oblikovane detajle. Izgleda krhka, vendar ni. Zaradi svetlobe in videza je njena moč vsestranska.







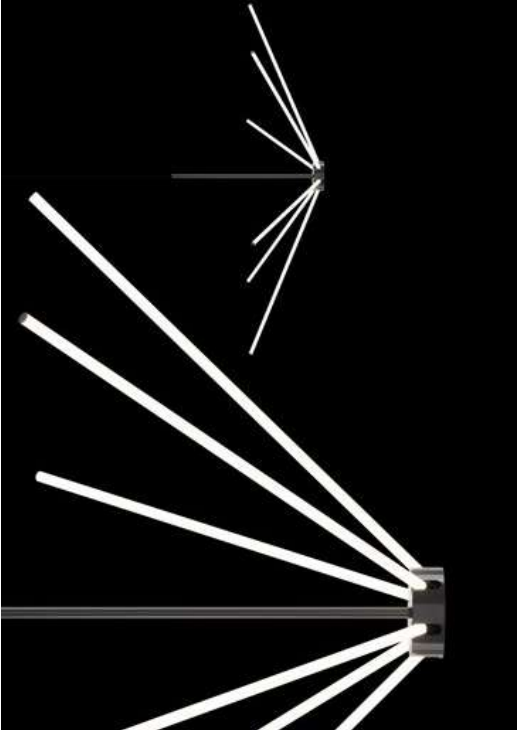

### One product, different looks

The different inclination of single tubes totally changes the product's appearance. Set it the way you like it, and change it over time. It will be like having a new luminaire.

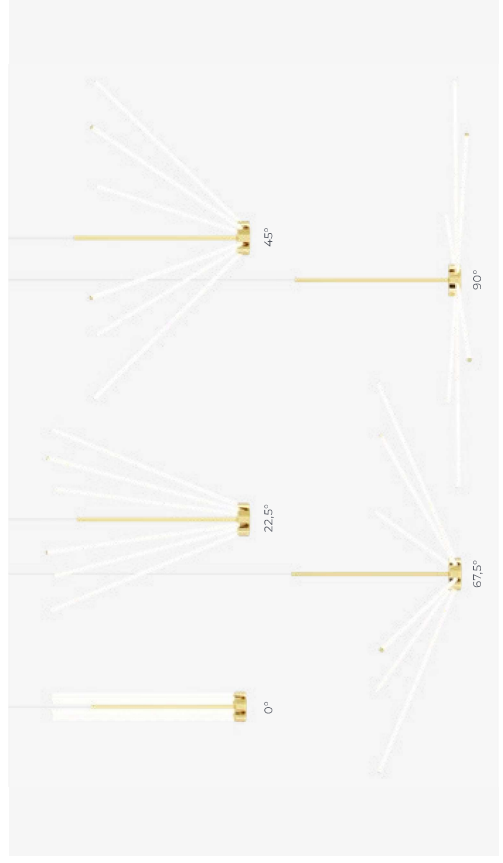

# Lysabel

## Technical Overview

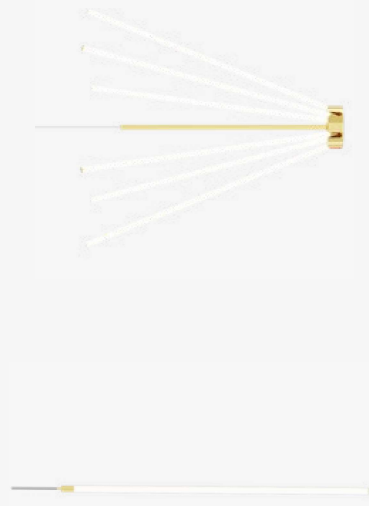

<b>S</b>	<b>Suspended vertical and horizontal</b>	<b>S C</b>	<b>Suspended chandelier</b>
<b>Luminaire luminous flux</b>	1100 - 4400 lm   1850 lm/m		3400 - 6800 lm   1850 lm/m x 6
<b>Optic</b>	SOP		SOP
<b>LED colour</b>	927, 930, 935, 940		927, 930, 935, 940
<b>Driver</b>	Casambi, DALI, FO		Casambi, DALI, FO
<b>Driver position</b>	Ceiling cup, remote		Ceiling cup, remote
<b>Colour finish</b>	A C H F Y		A C H F Y
<b>Dimensions</b>	L (mm): 565 - 2565 SH (mm): 1500, 3000, 5000		L (mm): 565 - 1261 SH (mm): 1500, 3000, 5000

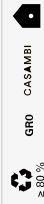
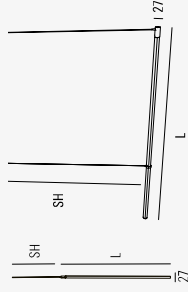

**Light source:** High-flux LED strip, CRI>90, MacAdam $\leq$ 2, 50,000h L90 B10 at 35°C. **Optic:** Satin opal polycarbonate diffuser (SOP). **Body:** Aluminium, powder or PVD coated. **Ceiling cup:** Ceiling cup with or without driver must be ordered separately. **Control gear:** Constant voltage driver - order separately. **Power supply:** 24V DC.

**Sorgente:** Strip LED High-flux, CRI $\geq$ 90, MacAdam $\leq$ 2, 50,000h L70 B10 a 35°C. **Optica:** Diffusore in policarbonato opale satinato (SOP). **Corpo:** Alluminio, verniciato a polvere o PVD. **Rosone:** Rosone con o senza alimentatore da ordinare separatamente. **Alimentazione:** Alimentatore a tensione costante - ordinare separatamente. **Alimentatore:** 24V DC.

**Svetlobni vir:** Visoko svetlen LED trak, CRI $\geq$ 90, barvno odstopanje MacAdams2, 50,000h L90 B10 na 35°C. **Optika:** Satiran opalni polikarbonatni difuzor (SOP). **Ohišje:** Aluminij, prašno ali PVD barvano. **Stropna rozeta:** Stropno rozeto z ali brez LED konverterja je potrebno naročiti ločeno. **Napajalniki:** LED konverter s konstantno napetostjo - ločeno naročanje. **Napajanje:** 24 V DC.

For the latest product data please refer to the web page. For accessories and colour selection use the online product configurator.

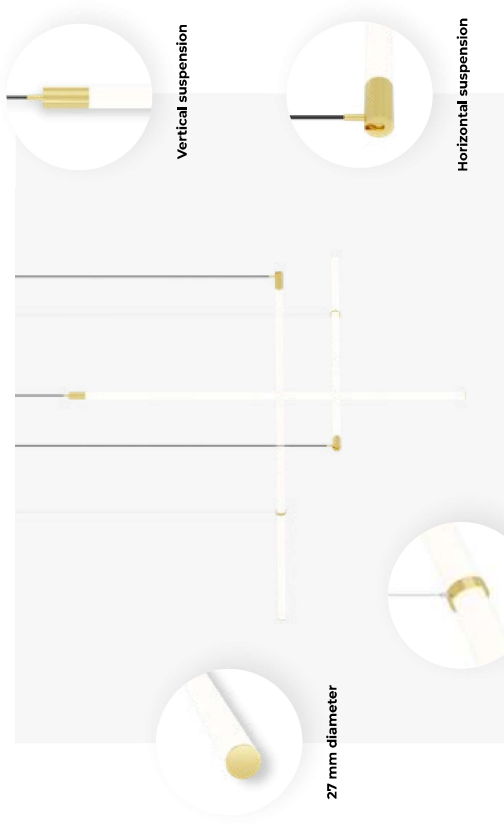

Suspension ring

### MAIN FEATURES

## Always slim in different lengths

Lysabel is available in different sizes. Combine them and create elegant compositions.

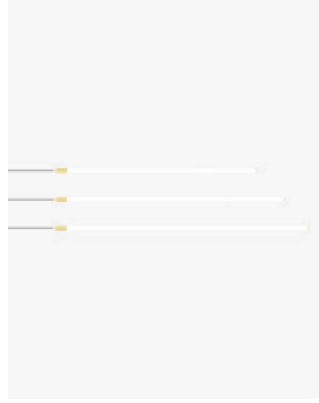

## It is also beautiful in horizontally

It can be wholly horizontal or a little inclined with a simple suspension ring. The ring also functions as an aesthetic accessory.

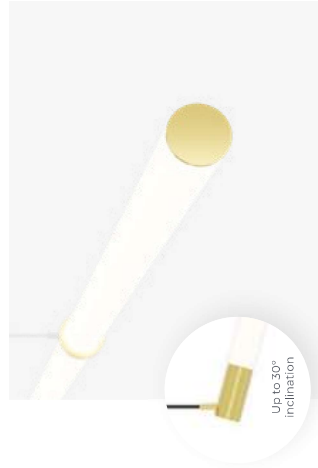

Up to 30° inclination





Big open spaces deserve to be arranged with style

Issa is an opal tube that shines along the entire length. One diameter and a variety of sizes allow lots of creativity in compositions.

It brings a general illumination to big open spaces, staircases and halls, with a touch of elegance. Due to its smooth milky surface and important size it stands out like a decorative element also when off.

Stile e design per i grandi open space

Issa è un tubo opalino che si illumina in tutta la sua lunghezza. Massima creatività delle composizioni, grazie all'unico diametro e all'ampia varietà di lunghezze.

Per l'illuminazione completa di grandi open space, scale e hall. Grazie alla superficie liscia bianca latte e alle dimensioni importanti, costituisce un elemento decorativo che si distingue anche a luce spenta.

Veliki odprti prostori si zaslužijo, da jih uredimo s slogom

Issaj je opalna cev, ki sije po celotni dolžini. Enoten premer in različne velikosti omogočajo veliko ustvarjalnosti pri kompozicijah.

Primerja je za splošno osvetlitev velikih odprtih prostorov, stopnišč in hodnikov s pridothom eleganco. Zaradi gladke mlečne površine in veliki izstopa kot dekorativni element, tudi ko ni prižgana.

# Issa

Miss impact









MAIN FEATURES

**It can be inclined on purpose**

Adjust the suspension height the way you prefer. Issa can be suspended. In line, completely vertically or a little inclined. The maximal inclination angle is 60°.



**Vertically or horizontally**

Or both. Mix and match different products the way you want.



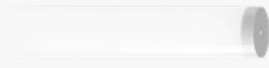
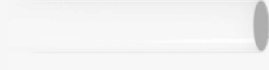
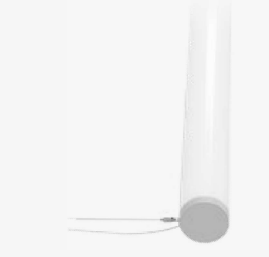

	<b>S H</b>	<b>S V</b>	<b>S VS</b>
<b>Luminaire luminous flux</b>	760 - 4900 lm   1460 lm/m	760 - 5900 lm   1460 lm/m	760 - 6900 lm   1460 lm/m
<b>Optic</b>	SOP	SOP	SOP
<b>LED colour</b>	927, 930, 935, 940	927, 930, 935, 940	927, 930, 935, 940
<b>Dynamic illumination</b>	RGB, Tunable white 2700-6500K	RGB, Tunable white 2700-6500K	RGB, Tunable white 2700-6500K
<b>Driver</b>	Casambi, DALI, FO	Casambi, DALI, FO	Casambi, DALI, FO
<b>Driver position</b>	Ceiling cup, remote	Ceiling cup, remote	Ceiling cup, remote
<b>Spot information</b>			
Luminaire luminous flux	-	-	up to 420
Beam angle	-	-	20°, 30°, 55°
LED colour	-	-	927, 930, 935, 940

	<b>1</b>	<b>2</b>	<b>1</b>	<b>2</b>
<b>Dimensions</b>	L (mm): 565 - 2565 SH (mm): 1500, 3000, 5000	L (mm): 544 - 3044 SH (mm): 1500, 3000, 5000	L (mm): 565 - 3068 SH (mm): 1500, 3000, 5000	L (mm): 565 - 3068 SH (mm): 1500, 3000, 5000



**Light source:** High-flux LED strip, CRI>90, MacAdams2, 50000h L90 B10 at 35°C, High-power COB LED, CRI>90, MacAdams2, 50,000h L90 B10 at 35°C, RGB LED strip optional. **Optic:** Satin opal polycarbonate diffuser (SOP). **Body:** Polycarbonate. **Ceiling cup:** Ceiling cup with or without driver must be ordered separately. **Control gear:** Driver must be ordered separately. **Power supply:** 24V DC/125mA.

**Sorgente:** Strip LED High-flux, CRI>90, MacAdams2, 50,000h L90 B10 a 35°C; COB LED High-power, CRI>90, MacAdams2, 50,000h L90 B10 a 35°C; strip LED RGB opzionale. **Optica:** Diffusore in policarbonato opale satinato (SOP). **Corpo:** Policarbonato. **Rosone:** Rosone con o senza alimentatore da ordinare separatamente. **Alimentazione:** Alimentatore da ordinare separatamente. **Alimentatore:** 24V DC/125mA.

**Svetlobni vir:** Visoko svetilen LED trak, CRI>90, barvno odstopanje MacAdams2, 50,000 h L90 B10 na 35 °C; Visoko učinkoviti COB LED modul, CRI>90, barvno odstopanje MacAdams2, 50,000 h L90 B10 na 35 °C; RGB LED trak opcijsko. **Optika:** Satiniran opalni polikarbonatni difuzor (SOP). **Ohišje:** Polikarbonat. **Stropna rozeta:** Stropno rozeto z ali brez LED konverterja je treba naročiti ločeno. **Napajalniki:** LED konverter je treba naročiti ločeno. **Napajanje:** 24 V DC/125 mA.



### Different lengths

Issa is available in different sizes. The combination of them creates a composition which adds an artistic touch to the ambience.

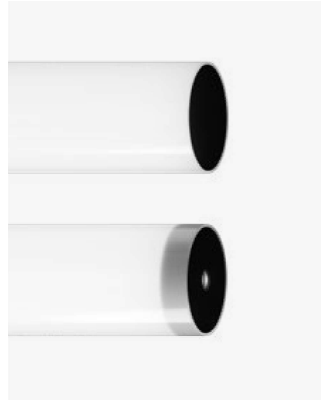

### Play with colours

Milky or tunable white is always a good choice. But sometimes, the RGB option gives an added value when creating a playful and dynamic atmosphere.

### With or without a spot

It depends on the intensity of light you want to achieve whether to choose a spot or not. Do you prefer Issa to shine vividly or to glow softly?

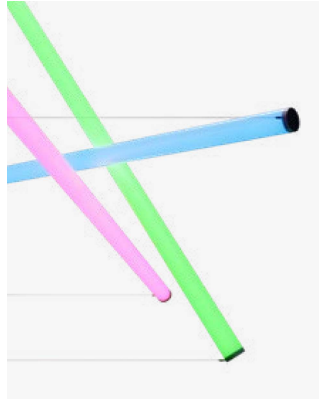





# Gramm

The lightest light

## Feather lightness in the space

Gramm is elegant and focused, meant to enlighten only what is needed. It is round-shaped, and its main feature is the possibility of rotation which allows a lot of flexibility. When you want a pleasant indirect light, you simply rotate it up with one move.

A name, a guarantee, Gramm will always bring a feeling of feather lightness to the space. Because Gramm is light, period.

## Leggera come piuma nello spazio

Gramm è elegante e funzionale, per illuminare solo laddove è necessario. La caratteristica distintiva, definita dalla forma rotonda, è la sua possibilità di rotazione. Per ottenere una luce indiretta e più gradevole, basta ruotarla verso l'alto con un solo gesto, e poi di nuovo verso il basso.

Un nome, una garanzia. Gramm porterà sempre nello spazio una sensazione di leggerezza, come una piuma. Perché Gramm è leggerezza, e questo basta.

## Peresna lahkotnost v prostoru

Gramm je elegantna svetilka, ki usmerjeno osvetljuje le, kar je potrebno. Je okrogle oblike, njena glavna prednost pa je možnost vrtenja, ki omogoča veliko prilagodljivosti. Ko želite prijetno indirektno svetlobo, jo preprosto zavrtite z enim gibom navzgor.

Gramm. Ime, ki pove vse. V prostor bo ta svetilka vedno prinesla občutek peresne lahkotnosti. Ker je preprosto lahka.





# Gramm

## Technical Overview

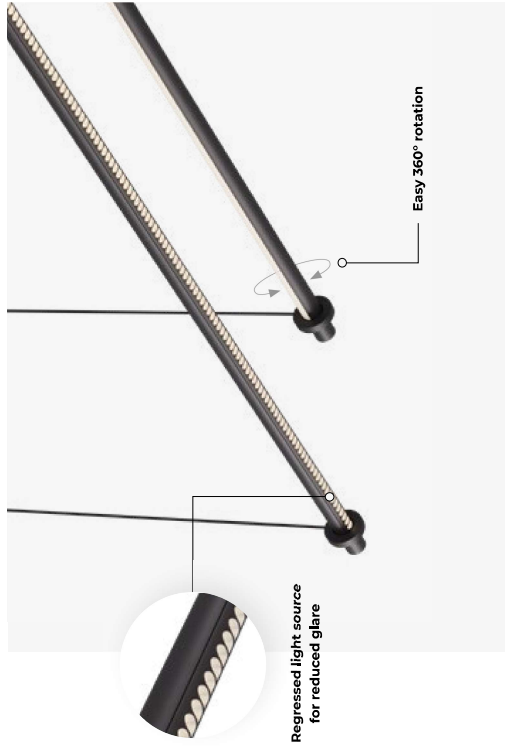

### MAIN FEATURES

#### Soft ambient light

This slim luminaire brings elegance and softness with both its looks and light. The optic offers a pleasant illumination with low glare, perfect for all situations when you don't need a classic office lighting.



#### Just rotate it for indirect light

You rotate it up with one move when you want a pleasant indirect light. This is its great advantage.



	S LGO	S SOP
Luminaire luminous flux/m	210 lm/m	681 lm/m
Optics	LGO	SOP
LED colour	927, 930, 940	927, 930, 940
Driver	Casambi, DALI, FO	Casambi, DALI, FO
Driver position	Ceiling cup / Remote	Ceiling cup / Remote
Colour	2	2
Dimensions	L (mm): 560 - 2060 SH (mm): 500 - 2000	L (mm): 560 - 2060 SH (mm): 500 - 2000



**Light source:** High-flux LED strip, CRI>90, MacAdam $\leq$ 2, 50000h L90 B10 at 35°C. **Optic:** Satin opal polycarbonate diffuser (SOP), Low glare linear grid optic (LGO). **Body:** Extruded aluminium profile, powder coated. **Ceiling cup:** Ceiling cup with or without driver must be ordered separately. **Control gear:** Constant voltage driver - order separately. **Power supply:** 24V DC.

**Sorgente:** Strip LED High-flux, CRI>90, MacAdam $\leq$ 2, 50.000h L90 B10 a 35°C. **Ottica:** Diffusore in polycarbonato opale satinato (SOP), Ottica con griglia lineare a basso abbagliamento. **Corpo:** Profilo in alluminio estruso, verniciatura a polvere. **Rosone:** Rosone con o senza alimentatore da ordinare separatamente. **Alimentazione:** Alimentatore a tensione costante - ordinare separatamente. **Alimentatore:** 24V DC.

**Svetlobni vir:** Visoko svetilen LED trak, CRI>90, barvno oddajanje MacAdam $\leq$ 2, 50.000 h L90 B10 na 35 °C. **Optika:** Satiniran opalni polikarbonatni difuzor (SOP), Linearna optična rešetka z omejenim bleščanjem (LGO). **Ohišje:** Ekstrudiran profil iz aluminija, prašno barvan. **Stropna rozeta:** Stropno rozeto z ali brez LED konverterja je potrebno naročiti ločeno. **Napajalnik:** LED konverter s konstantno napetostjo - ločeno naročanje. **Napajanje:** 24 V DC.





# Rylo Pro

Office first

## Your best office buddy

Whether it is suspended, recessed or floor, Rylo Pro is mostly intended for offices – for single ones, open spaces and conference rooms, offering illumination with no glare, high visual comfort and wellbeing.

The floor version of Rylo Pro is really practical, no installation needed, just plug-in and start. It is easy to move from one workstation to another.

## Il tuo collega migliore

Rylo Pro è pensato essenzialmente per l'ufficio: per spazi singoli, open space e sale conferenze. Può essere collocato in sospensione, incassato o a pavimento, per diffondere sempre una luce non abbagliante, per il massimo benessere e comfort visivo.

Nella versione da terra, Rylo Pro è una soluzione praticissima, che non richiede installazione. Si inserisce la spina e ci si mette al lavoro. Si trasferisce facilmente da una postazione di lavoro ad un'altra.

## Vaš najboljši pisarniški kolega

Ne glLEDa na to, ali je viseča, vgradena ali talna, je svetilka Rylo Pro večinoma namenjena pisarnam – individualnim, skupnim in konferenčnim sobam. Ponuja osvetljenost brez blešanja, visoko vizualno udobje in dobro počutje.

Talna različica Rylo Pro je resnično praktična: montaža ni potrebna, samo vključite jo in prižgete. Premikanje z ene delovne postaje na drugo je preprosto.

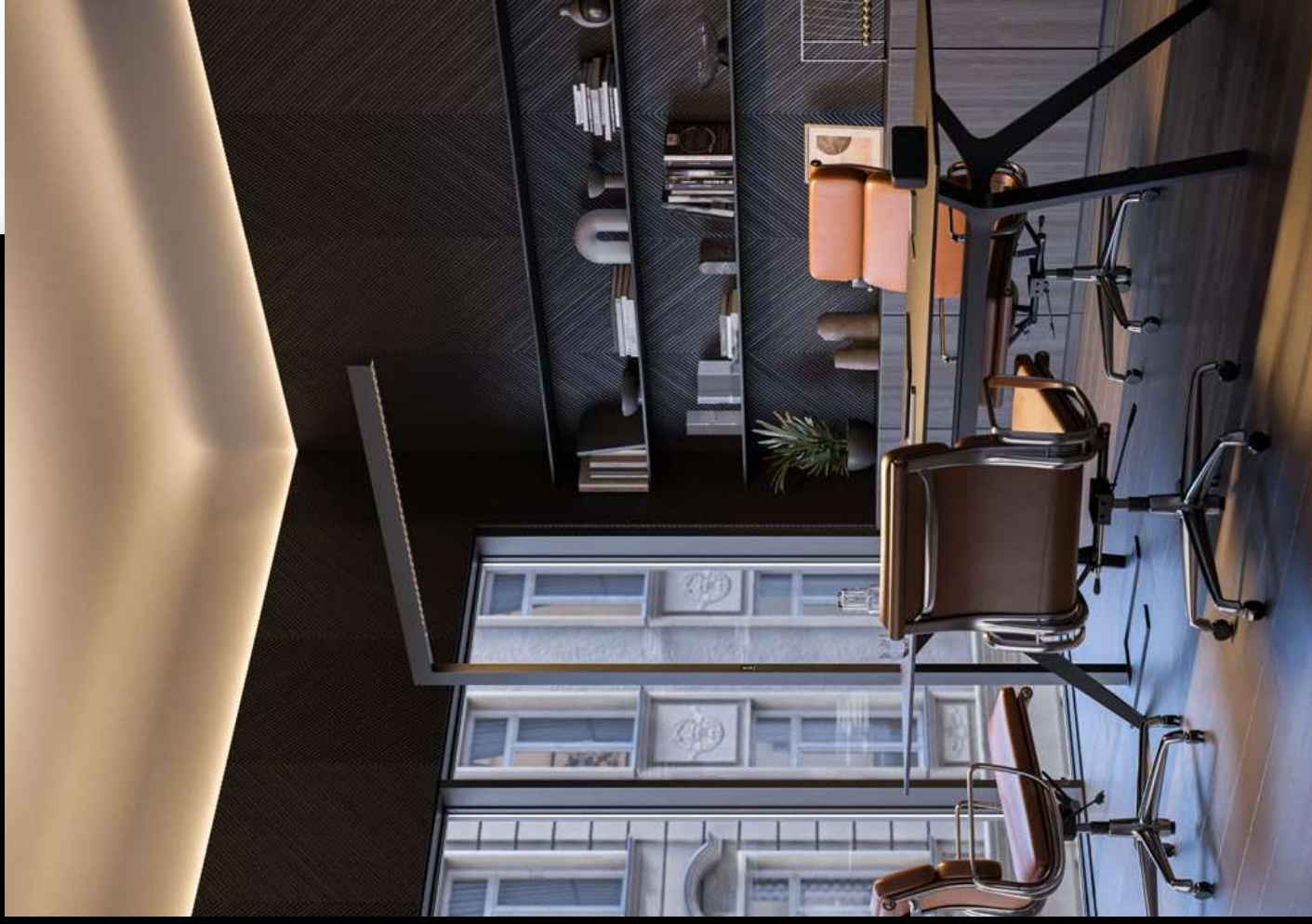

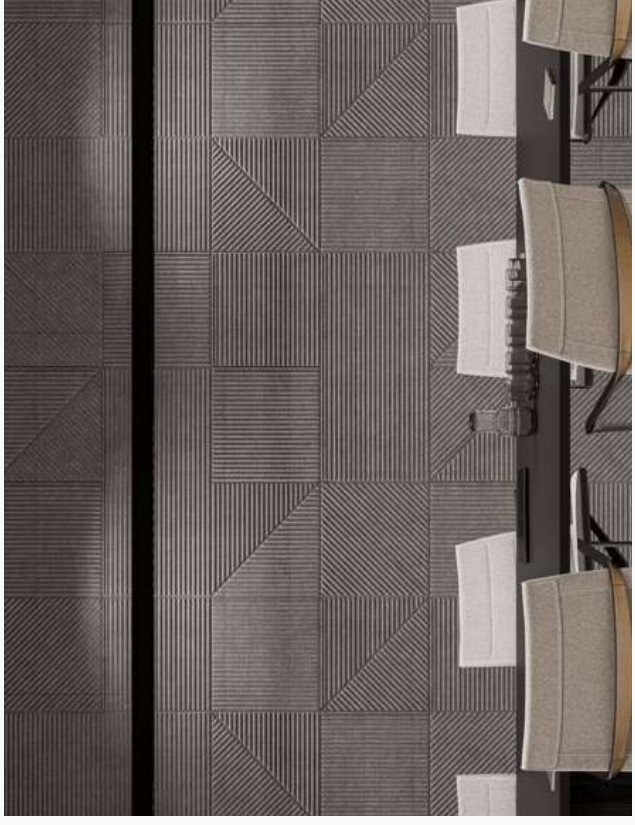









UGR <19

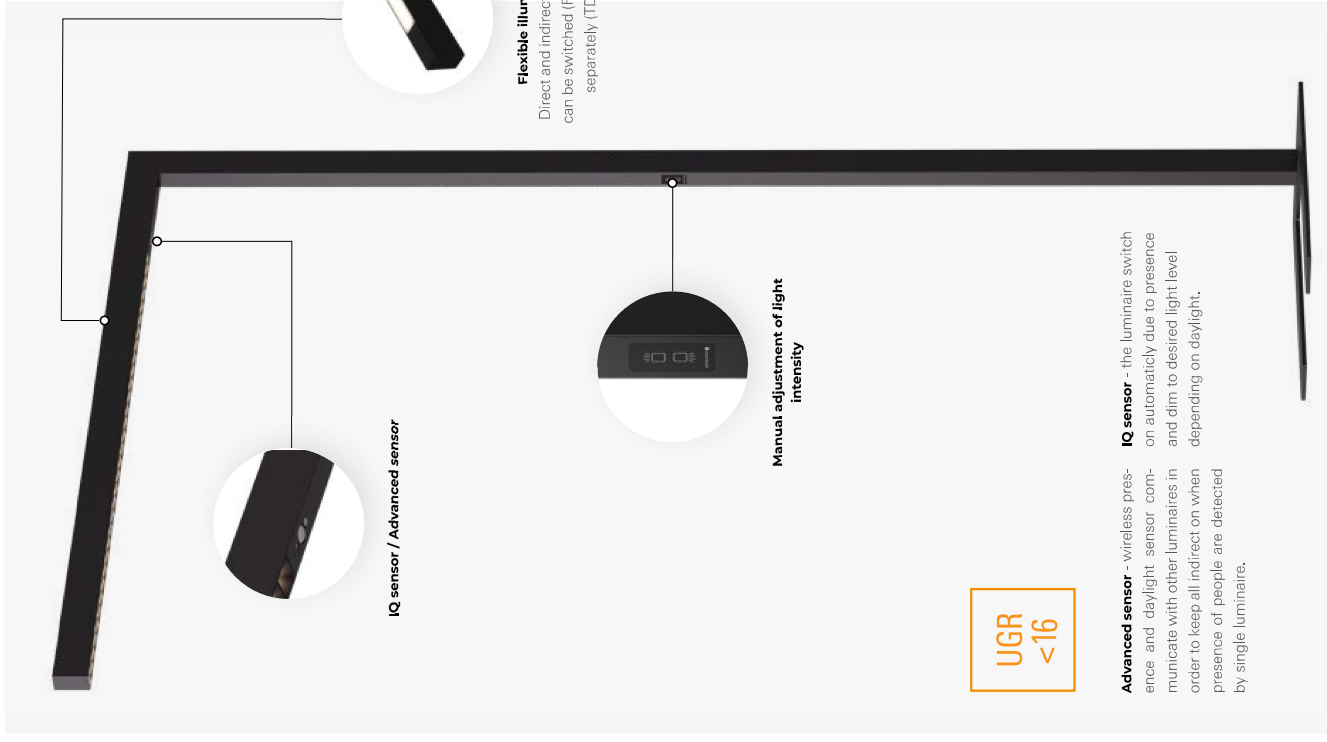

**IQ sensor / Advanced sensor**

**Flexible illumination**

Direct and indirect components can be switched (FO) or dimmed separately (TD version).

**Manual adjustment of light intensity**

UGR <16

**Advanced sensor** - wireless presence and daylight sensor communicate with other luminaires in order to keep all indirect when presence of people are detected by single luminaire.

**IQ sensor** - the luminaire switch on automatically due to presence and dim to desired light level depending on daylight.

**MAIN FEATURES**

**Wide family range**

The family range is wide—from single modules to linear systems, and also T forms for double desks.

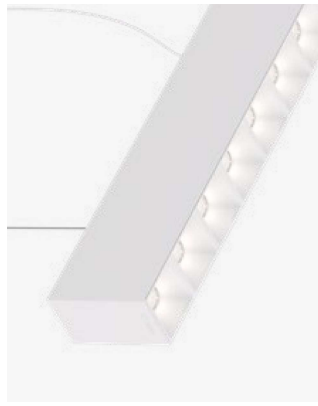

**No glare, light comfort**

Inappropriate lighting causes headaches and eye trouble. Create a healthier working environment with lighting which affects our well-being, mood and concentration. With indirect illumination you can create a softer light environment.

# Rylo Pro

## Technical Overview



	RI	RV	C/S	S/DI	S/S/DI	FDI	FDI T
	Recessed trimless	Recessed visible trim	Ceiling / Suspended	Suspended direct-indirect	Suspended direct / direct-indirect	Floor direct-indirect	Floor direct-indirect T shape
<b>Glare control (UGR class)</b>	UGR<19	UGR<19	UGR<19	UGR<19	UGR<19	UGR<16	UGR<16
<b>Luminaire luminous flux</b>	34-167 lm/spot	34-167 lm/spot	34-167 lm/spot	34-167 lm/spot	34-167 lm/spot	1700 lm + 3600 lm for LED colour 930	3400 lm + 7200 lm for LED colour 930
<b>Number of spots</b>	8+8, 16+16	8+8, 16+16	8+8, 16+16	8+8, 16+16	8+8, 16+16	32	32+32
<b>Light distribution</b>	Direct	Direct	Direct	Direct / Indirect	Direct, Direct / Indirect	Direct / Indirect	Direct / Indirect
<b>Optics</b>	50°, Asymmetric	50°, Asymmetric	50°, Asymmetric	50°, Asymmetric	50°, Asymmetric	50°	50°
<b>LED colour</b>	927, 930, 935, 940	927, 930, 935, 940	927, 930, 935, 940	927, 930, 935, 940	927, 930, 935, 940	927, 930, 935, 940	927, 930, 935, 940
<b>Driver</b>	Casambi, DALI, FO, IO sensor	Casambi, DALI, FO, IO sensor	Casambi, DALI, FO, IO sensor	Casambi, DALI, FO, IO sensor	Casambi, DALI, FO, IO sensor	Casambi, FO, IQ sensor, TD	Casambi, FO, IQ sensor, TD
<b>Driver position</b>	Integrated	Integrated	Integrated	Integrated	Ceiling cup	Integrated	Integrated
<b>Colour</b>	1 2	1 2	1 2	1 2	1 2	1 2	1 2

See the colour options below

L (mm): 1682 - 3082 SH (mm): 1500, 3000, 5000

See the colour options below

L (mm): 1962 - 3082 SH (mm): 1500, 3000, 5000

See the colour options below

L (mm): 1682 - 3082

See the colour options below

L (mm): 1682 - 3082

See the colour options below

L (mm): 1125 - 2805 SH (mm): 1500, 3000, 5000

See the colour options below

L (mm): 1125 - 2805 SH (mm): 1500, 3000, 5000

See the colour options below

L (mm): 1125 - 2805 SH (mm): 1500, 3000, 5000

See the colour options below

L (mm): 1125 - 2805 SH (mm): 1500, 3000, 5000

For C/S, S/DI, S/S/DI versions, the optical funnel and blind module colour are always black, except with the white version. \*Single module is possible by adding end caps to the Line module.



**Light source:** High-flux PCB LED modules, mid-power SMD LED, CRI>90, MacAdams2,5, 50,000h L90 B10 at 35°C, /High-power LED, CRI>90, MacAdams2,5, 50,000h L90 B10 at 35°C. **Optic:** Low glare spot optical system with UGR<19. Satin L80 B10 at 35°C. **Optica:** Sistema ottico spot a basso abbagliamento con UGR<19, L80 B10 at 35°C. **Optica:** Sistema ottico spot a basso abbagliamento con UGR<19, L80 B10 at 35°C. **Corpo:** Extruded aluminium Schermo opale satinato in polycarbonato (SOP) per luce indiretta. **Corpo:** Profilo in alluminio estruso, verniciatura a polvere. **Alimentazione:** Alimentatore ad alta efficienza on/off (FO) o dimmerabile (DALI+TD, Casambi) integrato. **Accessorie** separate opzionali per la versione luce diretta / indiretta. **Alimentatore:** 230V/50Hz.

**Standard:** 1 2 3 6 9 Special colours:

**Svetlobni vir:** High-flux PCB LED moduli, z SMD LED, CRI>90, MacAdams2,5, 50,000 h L90 B10 na 35 °C. / Visoko učinkovit COB LED modul, CRI>90, barvno odstopanje MacAdams2,5, 50,000 h L80 B10 na 35 °C. **Optika:** Reflektorski optični sistem z omejenim bleščanjem UGR<19. Opalini polikarbonatni difuzor (SOP) za indirektno osvetlitev. **Ohlajenje:** Ekstrudirani profil iz aluminija, prahno barvan. **Napajanje:** Integriran visoko učinkoviti LED konverter s konstantnim tokom (FO) ali regulacijskim zbirnikom (DALI+TD, Casambi). Opcijsko ločeno prižigalnje direktne / indirektno komponente. **Napajanje:** 230 V 50 Hz.



# Lynar

It's your move

## Sweet home for light modules

Lynar is an elegant, endless modular profile that offers maximum flexibility.

The choice of modules is wide and the installation is tool-free, simple, fast and safe. Combine them the way you want and change or move at anytime.

It covers a wide range of use - from office, galleries, retail, hospitality to private residences.

## L'accoglienza chiede modularità di luce

Lynar è un profilo modulare elegante e infinito che offre soluzioni di massima flessibilità.

L'ampia scelta dei moduli è accompagnata da modalità di installazione rapide e sicure, di una facilità che non richiede utensili. I moduli sono liberamente combinabili e possono sempre essere cambiati o riposizionati.

Ampia la gamma delle applicazioni: dagli uffici alle gallerie d'arte, dai negozi alle strutture ricettive ma anche alle abitazioni.

## Varno zavetlje svetilnih modulov

Lynar je eleganten, neskončen modularni profil, ki nudi maksimalno fleksibilnost.

Izbira modulov je bogata, montaža pa je možna brez orodja, je enostavna, hitra in varna. Kombinirajte jih tako, kot želite, in jih kadarkoli spremenite ali premaknite.

Zajema širok nabor uporabe - od pisarne, galerij, trgovin, gostinstva do zasebnih bivališč.





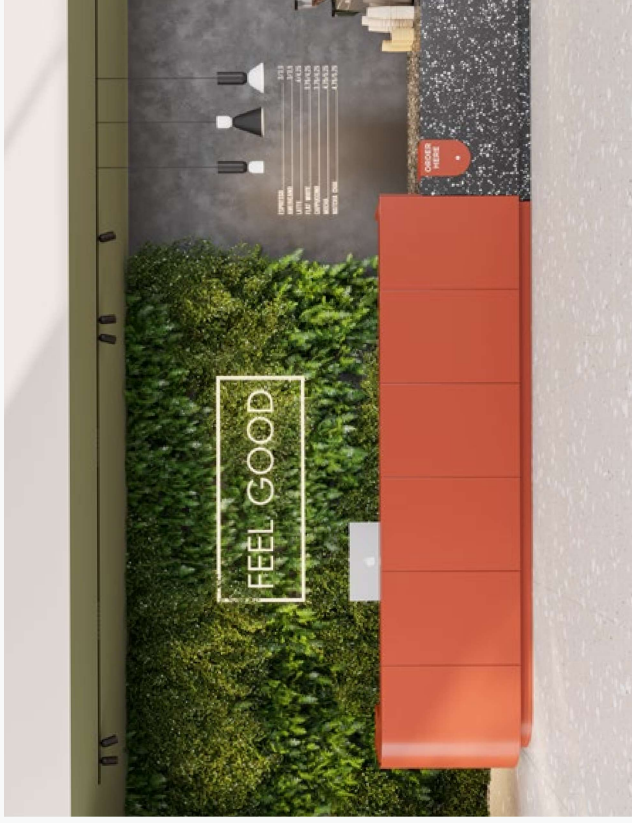

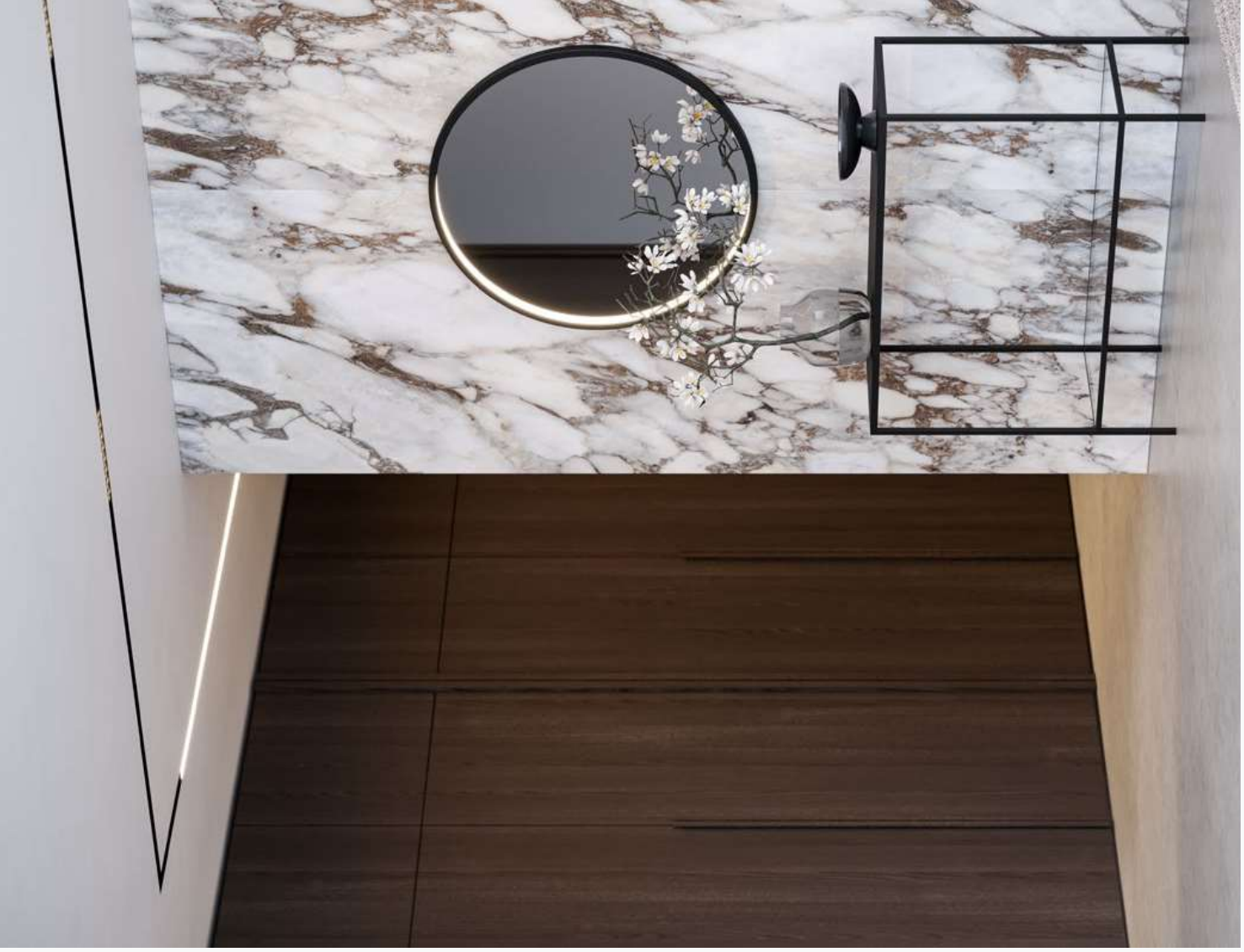

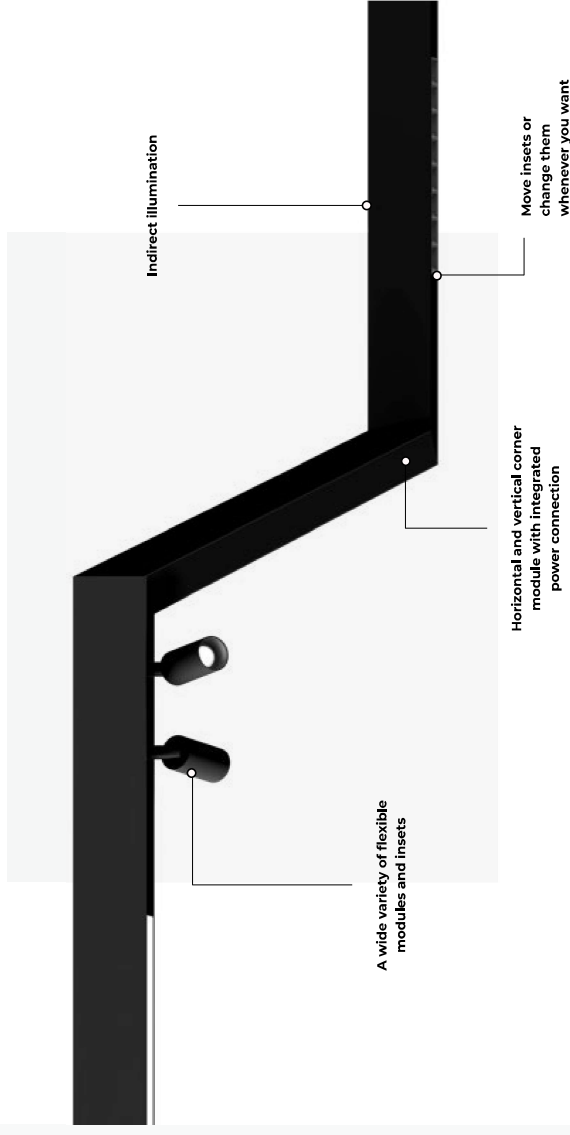

INSETS



Atos LYN



Eye LYN



Kallis 36 LYN



Ryfo LYN



Biba LYN



Pipes 45 S LYN



Pixy LYN



Zoe LYN







The profiles are available in different colours.  
The interior is always black.

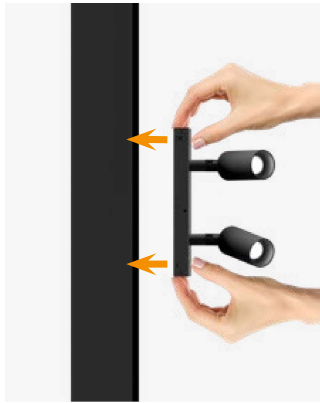
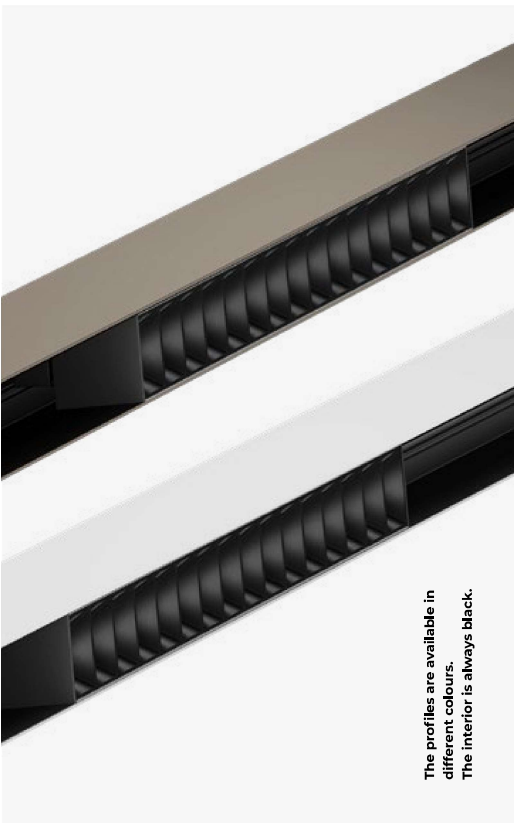

### Keep on moving

Get the maximum flexibility of adjusting the light in the space. Not just the first time, but anytime. Repositioning the modules has never been easier.

### Quick installation

The installation of modules is simple, fast and safe. The products are fixed with a mechanical coupling that ensures a reliable and lifelong grip.

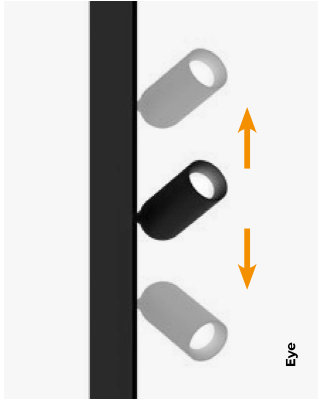

### Light line

Choose Kalls inset for general illumination. It can turn out very well in a composition as an interesting graphic element.

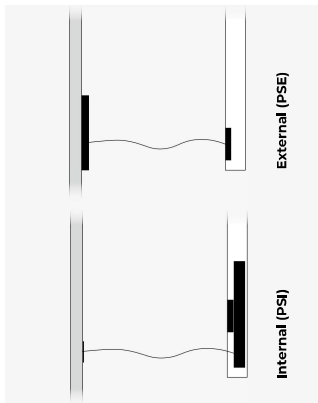

### Internal or external power supply

Depending on the desired visual effect and profile installation type, the power supply can be positioned inside the profile, externally in the ceiling cup or remotely.



	RI Recessed trim-less	RV Recessed visible trim	C/S Ceiling / Suspended	SDI Suspended Direct / Indirect
<b>Indirect luminaire luminous flux/m</b>	-	-	-	980 lm/m (DALI)
<b>LED colour</b>	-	-	-	827, 830, 835, 840, 930, 940
<b>Electrical connection</b>	48Vdc (not included, order separately)	48Vdc (not included, order separately)	48Vdc (not included, order separately)	48Vdc (not included, order separately)

Colour	D	1	2	3	6	9	+

Dimensions	L: 500 - 3000 mm	L: 500 - 3000 mm	L: 1000 - 3000 mm

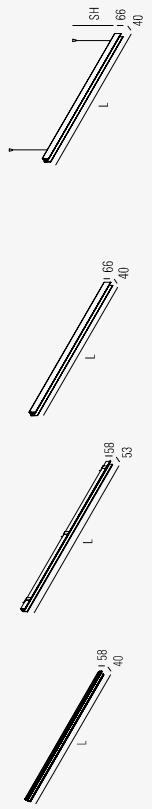

\*The inner part of the profile is always black

**GR0**
**GRI**
**CASAMEI**
**WARRANTY**
**CE**

Linear extruded aluminium profile system with integrated 48V track. Indirect light option with SOP diffuser. Wide range of light insets (linear, spot, pendant). Power supply can be mounted remotely (PSE) or inside the profile (PSI).

Sistema lineare in alluminio estruso con binario 48V integrato. Disponibile con luce indiretta con schermo SOP. Ampia gamma di lampade installabili (lineari, spot, pendenti). Il trasformatore può essere installato remoto (PSE) o all'interno del profilo (PSI).

Linijski sistem iz ekstrudiranega aluminjskega profila z vgrajeno 48 V tračnico. Možnost indirektna osvetlitve z opalnim difuzorjem vzdolž sistema. Širok nabor svetlobnih elementov (linearni, reflektorski, viseči). Napajalni modul je lahko montiran v sam profil (PSI) ali pa izven njega (PSE).

## Spot insets

### Atos LYN



**Luminaire luminous flux:** Up to 2x1050 lm  
**Beam angle:** 18°, 20°, 25°, 30°, 50°, 59°, 28°-46°  
**LED colour:** 827, 830, 840, 927, 930, 935, 940  
**Spots:** 1x / 2x  
**Driver:** DALI  
**Diameter:** 26, 32, 45 mm

### Eye LYN



**Luminaire luminous flux:** Up to 1400 lm  
**Beam angle:** 10°, 22°, 26°, 30°, 45°, 46°, 22-45°  
**LED colour:** 927, 930, 935, 940  
**Driver:** DALI  
**Diameter:** 60 mm

## Pendant insets

### Biba LYN



**Luminaire luminous flux:** Up to 936 lm  
**Beam angle:** 42°, 62°  
**LED colour:** 830, 840, 927, 930, 935, 940  
**Driver:** DALI  
**Diameter:** 75 mm

### Pipes 45 S LYN

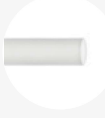

**Luminaire luminous flux:** Up to 1300 lm  
**Beam angle:** 42°, 62°  
**LED colour:** 830, 840, 927, 930, 935, 940  
**Driver:** DALI  
**Diameter:** 45 mm

### Pixy LYN



**Luminaire luminous flux:** Up to 3100 lm  
**Beam angle:** 30°, 50°  
**LED colour:** 830, 840, 927, 930, 935, 940  
**Driver:** DALI

### Zoe LYN



**Luminaire luminous flux:** Up to 1481 lm, 12W  
**LED colour:** 830, 840, 927, 930, 935, 940  
**Driver:** DALI

## Linear insets

### Kalis 36 LYN



**Luminaire luminous flux:** Up to 1800 lm  
**Module length:** 285 mm - 1405 mm  
**Optic:** SOP, DPR  
**LED colour:** 827, 830, 835, 840, 930, 940  
**Driver:** DALI

### Rylo LYN



**Luminaire luminous flux:** 60 - 130 lm/spot  
**Module length:** 143 mm - 843 mm (4x - 24x spot)  
**Beam angle:** 22°, 30°, 50°, Asymmetric  
**LED colour:** 927, 930, 935, 940  
**Driver:** DALI

## Corner profiles

### Horizontal corner



90° and 135°  
 Integrated PWR connection module  
 Dimension: 50x50 mm

### Vertical corner



90°  
 Integrated PWR connection module  
 Dimension: 50x50 mm

## Power supply



**PSE - power supply external**  
**PWR supply position:** Integrated in the ceiling cup  
**PWR supply type:** 48V constant voltage driver



**PSI - power supply internal**  
**PWR supply position:** Integrated in the profile inset  
**PWR supply type:** 48V constant voltage driver



# Liiy

## Maximally minimal

### Pure light effect

Liiy is perfect for elegant spaces where you just can't have an ordinary spot. Its main advantage is the appearance of pure light without any source glare. It is minimalist. Imagine, the opening on the bottom of the funnel is only 6 mm wide. Then, it depends on the housing colour whether you want the whole luminaire to stand out or to completely blend in.

Liiy can perform as a single spot, in a pair, or in a row of three, four or more. It can be fixed or flexible, allowing to change the beam angle and orientation, always having visual attention on the object.

### La purezza della luce

Liiy è la soluzione perfetta per quegli spazi eleganti in cui non ci si può accontentare di un'illuminazione comune. Il suo vantaggio principale risiede nel suo aspetto di luce pura, senza alcun tipo di abbagliamento. La sua forza è nel minimalismo: l'apertura nella parte inferiore del corpo lampada ha un'ampiezza di soli 6 mm. A seconda dello stile dell'ambiente si può decidere se fare risaltare l'intera lampada o se fonderla completamente con l'ambiente.

Liiy si presta come punto luce singolo oppure può essere utilizzata in coppia o anche in una fila di tre, quattro o più punti luce. Può rimanere in posizione fissa o mobile, permettendo di modificare l'angolo e l'orientamento del fascio, concentrando sempre l'attenzione sull'oggetto.

### Čisti svetlobni učinek

Liiy je kot nalašč za elegantne prostore, v katerih navadnega reflektorja preprosto ne morete imeti. Njegova glavna prednost je čista svetloba brez bleščanja svetlobnega vira. Je minimalistična. Predstavljajte si, da je odprtina na dnu lijaka široka le 6 mm. Od barve ohišja je odvisno, ali želite, da celotna svetilka izstopa ali se popolnoma neopazno zlije s stropom.

Liiy lahko prostor osvetljuje samostojno, v paru ali v vrsti treh, štirih ali več reflektorjev. Lahko je fiksna ali fleksibilna, kar omogoča spreminjanje kota in usmerjenosti žarka ter ohranja vizualno pozornost na predmetu.



Photo: Frank & Jesse van Oort



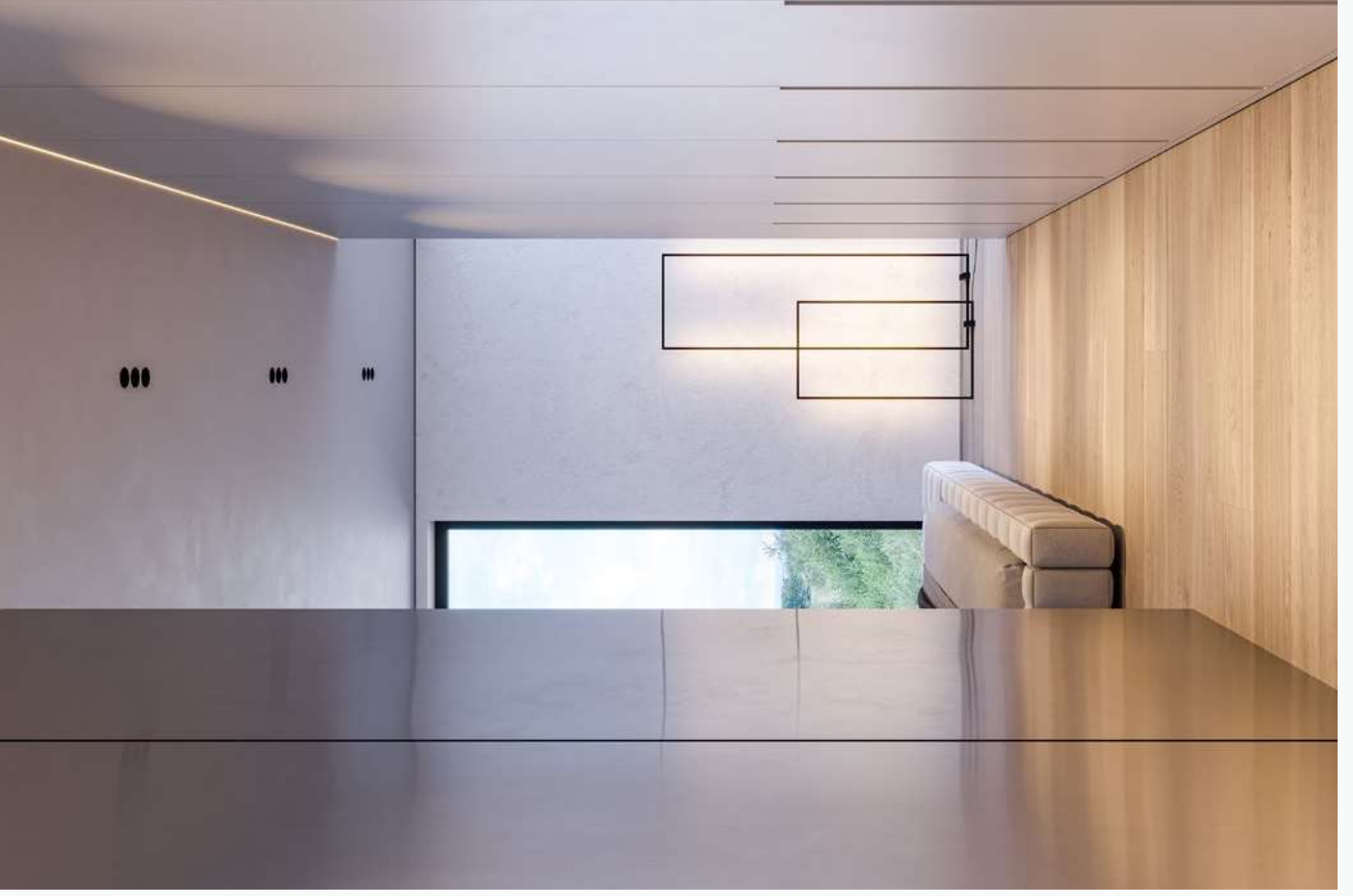

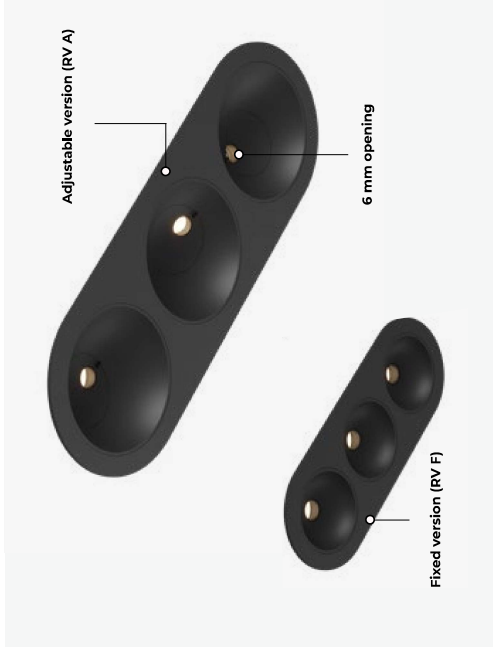

MAIN FEATURES

Double rotation and clean looks

With a simple gesture you can change both, the direction and the inclination angle of the light. In a row of spotlights, you can set each spot individually. And then change it when needed.

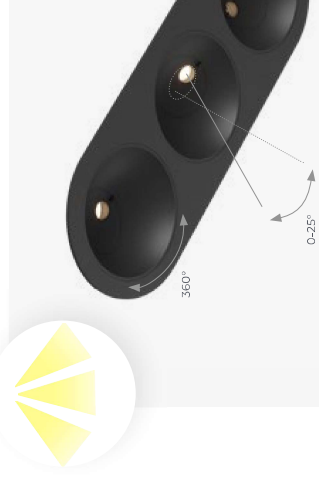

Trim-less installation

For a precise and clean trim-less installation of two or three spots in a row, you can use the installation kit. In this case the "only light" effect is even greater.



The product has a custom colour.



**RI**  
Recessed trim-less



**RV**  
Recessed visible trim

	<b>F</b>	<b>A</b>
<b>Beam angle</b>	Fixed	Adjustable
<b>Orientation</b>	LFO 33°, 48°	LFO 33°, 48°
<b>Luminaire luminous flux*</b>	up to 200 lm / spot	up to 200 lm / spot
<b>LED colour</b>	927, 930, 935, 940	927, 930, 935, 940
<b>Driver</b>	Casambi, DALI, FO	Casambi, DALI, FO
<b>Driver position</b>	Remote	Remote
<b>IP protection**</b>	IP44	IP44
<b>Colour</b>	1 2	1 2

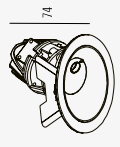
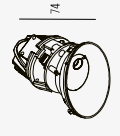
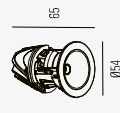

**Dimensions**

\* The data refer to one spot. Multiply the number with the number of spots. \*\* IP value from the exposed side



**Light source:** High-power LED, CRI>90, MacAdams2.5, 50,000h L80 B10 at 35°C. **Optic:** Acrylic glare-free LFO lens. **Body:** Polycarbonate. Optional with metalized coating. **Control gear:** Constant current driver - order separately. **Power supply:** 500 - 900 mA.

**Sorgente:** High-power COB LED, CRI>90, MacAdams2.5, 50,000h L80 B10 at 35°C. **Optica:** Lente acrilica glare-free LFO. **Corpo:** Polycarbonato. Opzionale con rivestimento metallizzato. **Alimentazione:** Alimentatore a corrente costante - ordinare separatamente. **Alimentatore:** 500 - 900 mA.

**Svetlobit vir:** Visoko učinkovit COB LED modul, CRI>90, barvno odstopanje MacAdams2.5, 50,000h L80 B10 na 35°C. **Optika:** Akrilna LFO leča brez bleščanja. **Ohišje:** Polikarbonat. Opcijsko z metalizirano prevleko. **Napajalnik:** LED konverter s konstantno tokom - ločeno naročanje. **Napajanje:** 500 - 900 mA.

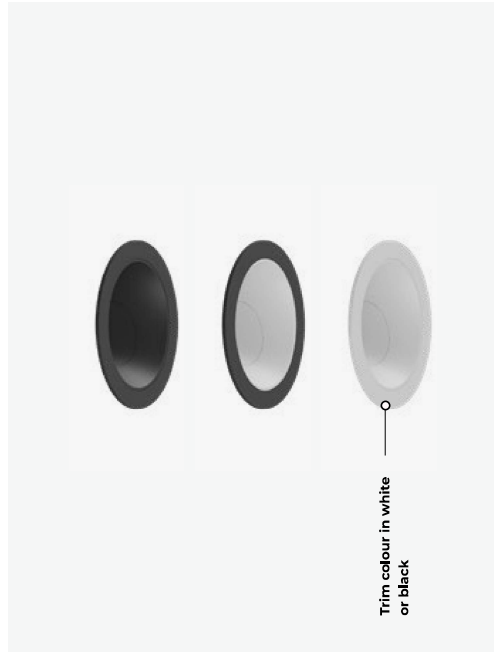

Trim colour in white or black

### OPTICS

## LFO - A guarantee of maximum visual comfort

Due to special design of Bartenbach LFO optic, all you can see is pure light. The light source is hidden deep inside the optics offering high visual comfort.

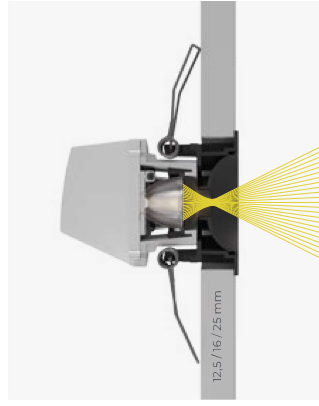

## No double ring

With the Bartenbach LFO optic the light circle is well-defined and homogenous. At the limits the light intensity is still high.

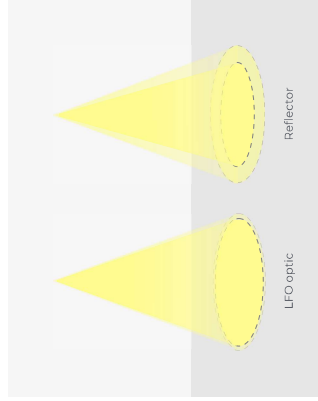



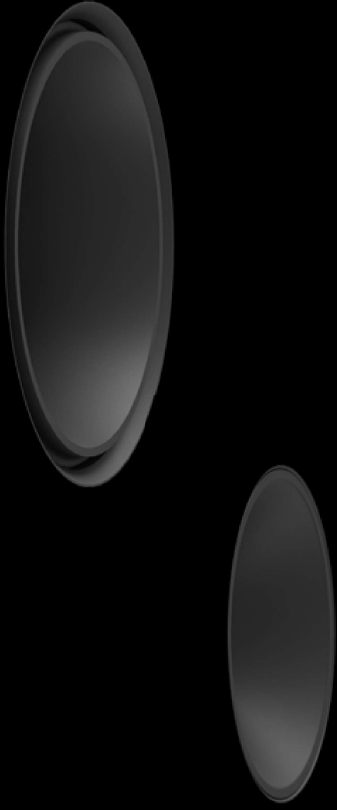

# Conic

An iconic spot

## No need to putty at all

When you want a spot on a higher level, choose Conic. It's distinguished by prestigious finishes, with range of colours and clean looks.

Most of all, Conic stands out for its innovative, easy and clean installation in a finished plaster ceilings, with tools of standard sizes and no puttying.

## Non rimarrà di stucco

Se vuoi un faretto spot di livello superiore, c'è Conic. Ha finiture di pregio, una vasta gamma di colori e un aspetto semplice.

Ma soprattutto prevede una soluzione di installazione innovativa, semplice e pulita, per controsoffitti in gesso con l'utilizzo di strumenti standard senza dover stuccare.

## Pozabite na kitanje

Ko želite reflektor višjega ranga, izberite Conic. Odlikuje ga prestižni premazi, široka paleta barv in čist videz.

Predvsem pa Conic izstopa po svoji inovativni, enostavni in čisti vgradnji v mavčne stropne z orodjem standardnih velikosti in brez izravnave površin s kitanjem.



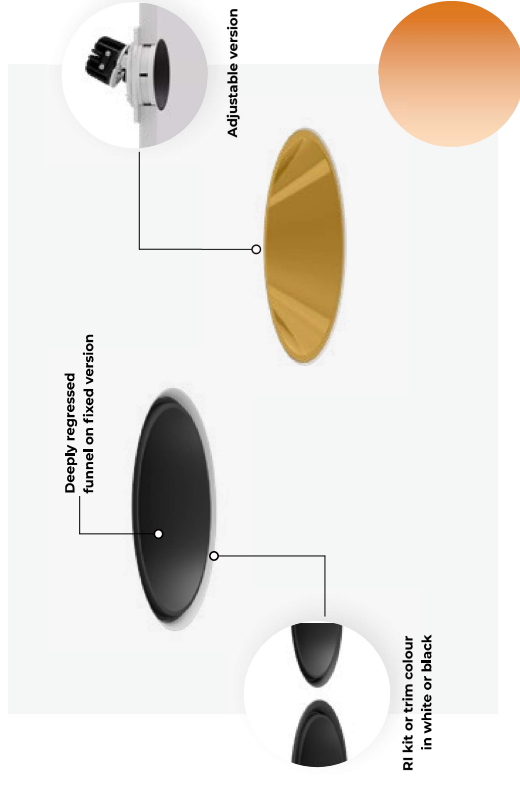

MAIN FEATURES

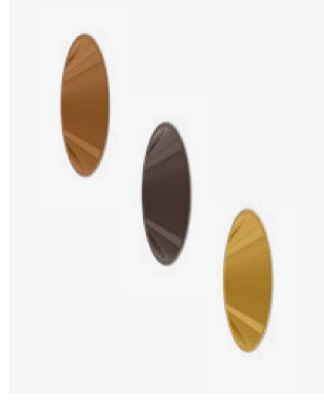

**Prestigious look with trendy colours**

The interior of the funnel can be gold, bronze or onyx coated which gives a luminaire prestigious look. Gold & bronze are on trend, but at the same time timeless chic finishes, perfect to match all kinds of interiors.

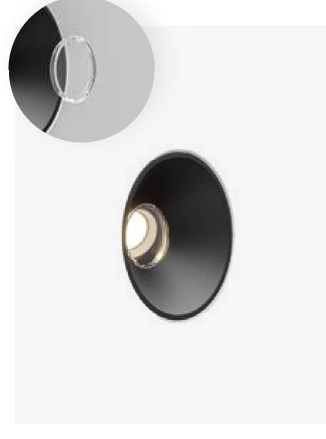

**IP44**

It's the perfect solution for high moisture environments like bathrooms. It offers pleasant and functional light as well as IP44 protection.

# Conic

## Technical Overview



### ADJUSTABLE (A)

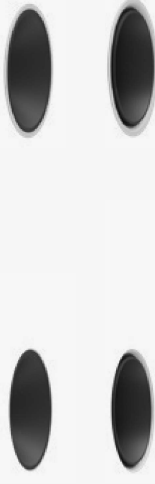

### FIXED (F)

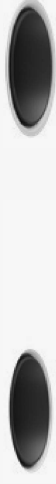

**RI** Recessed trim-less  
**RV** Recessed visible trim

**Beam angle**

20°, 30°, 55°

**Orientation**

25° / 360° (A)

**Luminaire luminous flux**

up to 1100 lm

**LED colour**

927, 930, 935, 940

**Dynamic light**

Dim to warm (D2W)\*\*

**Driver**

Casambi, DALI, FO

**Driver position**

Remote

**IP protection\***

IP44

**RI kit / Frame colour**

1 2

**Inner colour**

1 2 H F Y

### Dimensions

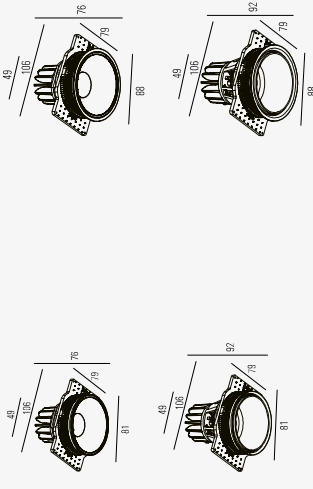

\*IP value from the exposed side. \*\*Dim to warm is possible on 55° beam angle.



**Light source:** High-power COB LED, CRI>90, MacAdams2, 50,000h L90 B10 at 35°C. **Optic:** High-efficient with uniform distribution, metalized polycarbonate with lacquer finish. **Body:** Polycarbonate, carbonato, Optional con rivestimento metallizzato. **Alimentazione:** Alimentatore a corrente costante - Constant current driver - order separately. **Power supply:** 150 - 900 mA.

**Sorgente:** High-power COB LED, CRI>90, MacAdams2, 50,000h L90 B10 a 35°C. **Ottica:** Ottica ad alta efficienza con distribuzione uniforme, polycarbonato metallizzato tramite laccatura. **Corpo:** Polycarbonato, Opzionale con rivestimento metallizzato. **Alimentazione:** Alimentatore a corrente costante - ordinare separatamente. **Alimentatore:** 150 - 900 mA.

**Svetlobni vir:** Visoko učinkovit COB LED modul, CRI>90, barvno odstopanje MacAdams2, 50,000 h L90 B10 na 35 °C. **Optika:** Visoko učinkovit metaliziran in lakiran polikarbonat z enakomerno porazdelitvijo svetlobnega snopa. **Omšjeje:** Polikarbonat, Opcijsko svetlobnega prevleko. **Napajalniki:** LED konverter z metalizirano prevleko. **Napajanje:** LED konverter s konstantnim tokom - ločeno naročanje. **Napajanje:** 150 - 900 mA.

For the latest product data please refer to the web page. For accessories and colour selection use the online product configurator.

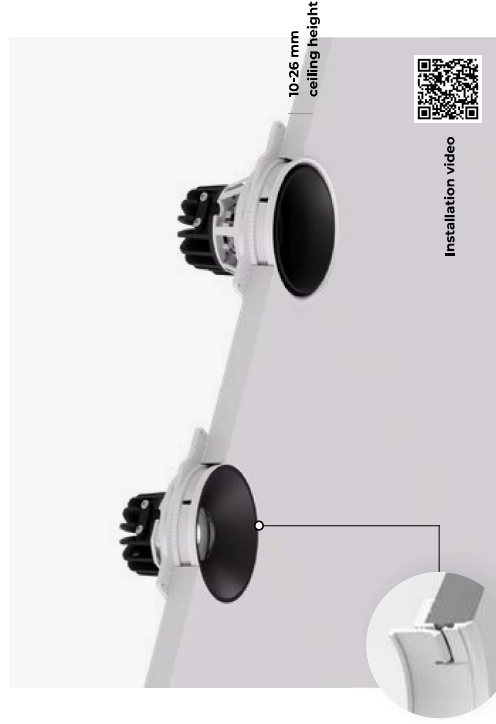

**RI kit for installation without puttying**

### REVOLUTIONARY TRIM-LESS INSTALLATION



Make a hole with a standard 80 mm hole saw



Paint the ceiling, no puttying needed



Twist and level the RI kit with the ceiling



Click in the spot and the funnel





# Rylo

Extraordinary light comfort

If you don't want to see where the light comes from, this is the solution

Rylo is not a common downlight. With its special optics it provides high visual comfort and generates circular light emission.

It doesn't show off. The light source is hidden and all you can see is pure light with absolutely no glare. It is universal, perfect for all spaces and projects.

Se non vuoi vedere da dove proviene la luce, questa è la soluzione

Rylo non è un normale faretti a luce diffusa. Le speciali soluzioni ottiche generano un'emissione luminosa spot per un elevato comfort visivo.

Non vuole certo mettersi in mostra. La fonte luminosa rimane nascosta e quello che si vede è pura luce senza abbagliamento. Perfetto per tutti gli spazi e progetti.

Ce ne želite videti, od kod prihaja svetloba, je to rešitev

Rylo ni običajen reflektor. S svojo posebno optiko zagotavlja veliko vizualno udobje in ustvarja krožno oddajanje svetlobe.

Se ne izpostavlja. Vir svetlobe je skrit in vse, kar lahko vidite, je čista svetloba popolnoma brez bleščanja. Je univerzalen, primeren za vse prostore in projekte.







# Rylo

## Technical Overview

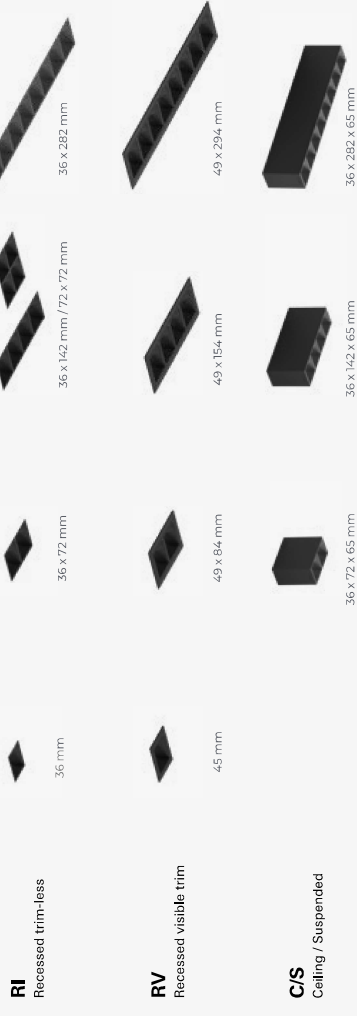

	1x	2x	4x	8x
<b>Beam angle</b>	22°, 30°, 50°, Asymmetric	22°, 30°, 50°, Asymmetric	22°, 30°, 50°, Asymmetric	22°, 30°, 50°, Asymmetric
<b>Luminaire luminous flux</b>	up to 200 lm/spot	up to 160 lm/spot	up to 160 lm/spot	up to 160 lm/spot
<b>Glare control</b>	<19	<19	<19	<19
<b>LED colour</b>	927, 930, 935, 940	927, 930, 935, 940	927, 930, 935, 940	927, 930, 935, 940
<b>Driver</b>	Casambi, DALI, FO	Casambi, DALI, FO	Casambi, DALI, FO	Casambi, DALI, FO
<b>Driver position</b>	Remote	Remote / In the ceiling cup	Remote / In the ceiling cup	Remote / In the ceiling cup
<b>Colour</b>	1 2	1 2	1 2	1 2

GR0 CASAMBI

CE

**Light source:** High-flux PCB LED modules, mid-power SMD LED, CRI>90, MacAdams2, 50,000h L90 B10 at 35°C, /High-power LED, CRI>90, MacAdams2, 5, 50,000h L80 B10 at 35°C. **Optic:** Low glare spot optical system with UGR<19. **Body:** Extruded aluminum profile, powder coated. **Control gear:** Constant current driver - order separately. **Power supply:** 250 - 1000mA.

**Sorgente:** Moduli PCB LED High-flux, SMD LED mid-power, CRI>90, MacAdams2, 50,000h L90 B10 a 35°C, / High-power COB LED, CRI>90, MacAdams2, 5, 50,000h L80 B10 a 35°C. **Ottica:** Sistema ottico spot a basso abbagliamento con UGR<19. **Corpo:** Profilo in alluminio estruso, verniciatura a polvere. **Alimentazione:** Alimentatore a corrente costante - ordinare separatamente. **Alimentatore:** 250 - 1000mA.

**Svetlobni vir:** High-flux PCB LED moduli, z SMD LED, CRI>90, MacAdams2, 50,000 h L90 B10 na 35 °C, Visoko učinkovit COB LED modul, CRI>90, barvno odstopanje MacAdams2, 5, 50,000 h, L80 B10 na 35 °C. **Optika:** Reflektorski optični sistem z omejenim blabljanjem UGR<19. **Ohišje:** Ekstrudiran profiliz aluminijski, prašno barvan. **Napajalnik:** LED konverter s konstantnim tokom - ločeno naročanje. **Napajanje:** 250 - 1000 mA.

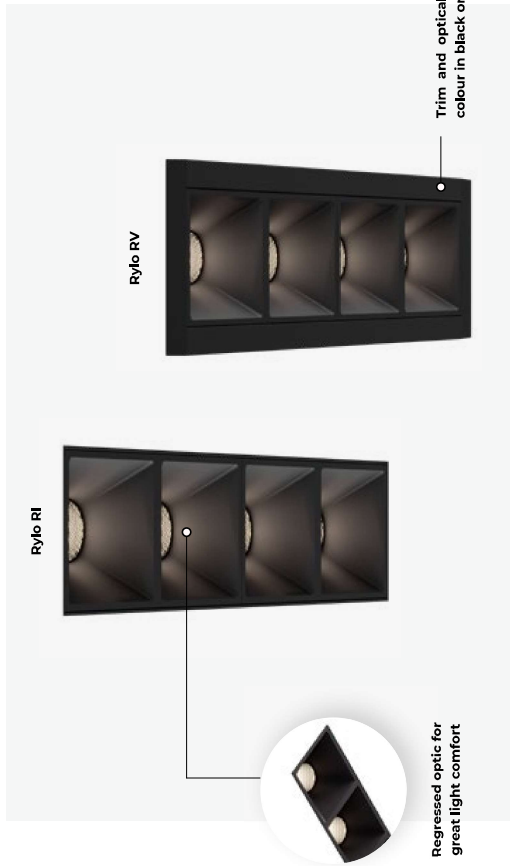

### MAIN FEATURES

**A luminaire for life**  
Clean, timeless design, high visual comfort, perfect fusion with space and minimalist looks make it a luminaire you will never get tired of.

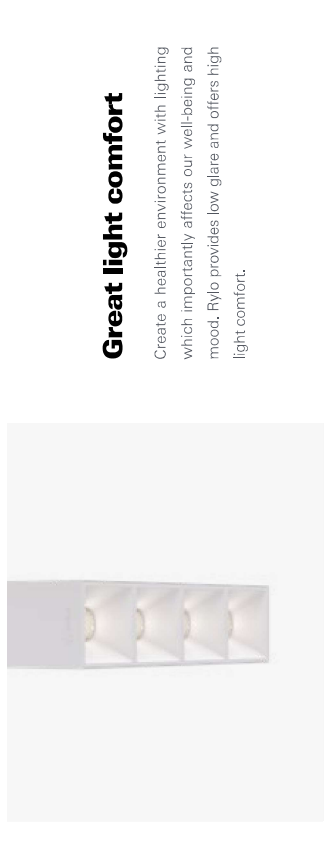

**Great light comfort**  
Create a healthier environment with lighting which importantly affects our well-being and mood. Rylo provides low glare and offers high light comfort.



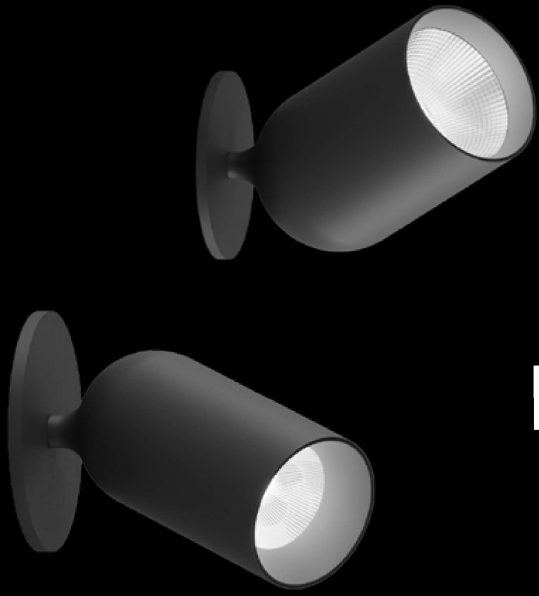

# Eye

Good looking all around

Don't roll your eyes, roll your Eye

There are really a lot of spots out there, but Eye is not just «one more spot». Come closer. All the details are carefully thought out. Its clean elegant look with the possibility of a 360-degree orientation makes it a perfect luminaire for hospitality, retail and private residences.

Eye, un occhio sul tuo mondo

Esistono tantissimi faranti spot sul mercato, ma Eye non è come gli altri. Guarda bene, Vedrai che ogni dettaglio è stato studiato con attenzione. Il design pulito ed elegante, orientabile a 360 gradi ne fa una lampada ideale per strutture ricettive, negozi, abitazioni. Usa Eye dove preferisci; grazie all'elevata classe di protezione IP, potrai adottare lo stesso stile sia per gli interni che per gli esterni.

Ne zavijajte z očmi, zavrite Eye

Obstaja res veliko točkovnih svetil, vendar Eye ni zgolj eno izmed njih. Približajte se. Vsi detajli so skrbno premišljeni. Zaradi čistega elegantnega videza z možnostjo 360-stopinjske orientacije je popolna svetilka za gostinstvo, maloprodajo in zasebna bivališca.







# Eye

## Technical Overview



**C 60**  
Ceiling

**C 80**  
Ceiling

**T 60**  
Track

**T 80**  
Track

### Beam angle

Reflector	34°, 45°	30°, 65°	34°, 45°	30°, 65°
Lens	10°, 22°, 26°, 46°	24°, 34°, 53°	10°, 22°, 26°, 46°	24°, 34°, 53°
Zoom lens	22° - 45°	-	22° - 45°	-

### Orientation

	65° / 360°	65° / 360°	65° / 360°	65° / 360°
--	------------	------------	------------	------------

### Luminaire luminous flux

	up to 1400 lm*	up to 2800 lm	up to 1400 lm	up to 2800 lm
--	----------------	---------------	---------------	---------------

### LED colour

	927, 930, 935, 940	830, 840, 927, 930, 935, 940	927, 930, 935, 940	830, 840, 927, 930, 935, 940
--	--------------------	------------------------------	--------------------	------------------------------

### Driver

	Casambi, DALI, FO	Casambi, DALI, FO	Casambi, DALI, FO	Casambi, DALI, FO
--	-------------------	-------------------	-------------------	-------------------

### Driver position

	Remote	Remote	Track adapter	Track adapter
--	--------	--------	---------------	---------------

### Colour

	<b>B</b> <b>D</b> <b>J</b>	<b>B</b> <b>D</b> <b>J</b>	<b>B</b> <b>D</b>	<b>B</b> <b>D</b>
--	----------------------------	----------------------------	-------------------	-------------------

### Dimensions

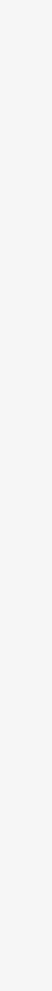

\* The data refer to one spot. Multiply the number with the number of spots.



GR0

GRI

CASAMBI



GR0

CASAMBI



WARRANTY



**Light source:** High-power COB LED, CRI>80/90, MacAdam's2, 50,000h, L90 B10 at 35°C. **Optic:** Highly efficient with uniform distribution, metalized polycarbonate with lacquer finish / Highly efficient PMMA optical lenses / Acrylic high efficiency lens with adjustable beam angle. **Body:** Aluminium, powder coated. **Control gear:** integrated highly-efficient driver with fixed output (FO) or dimmable (DALI-TD, Casambi). / Some versions require externally mounted driver - order separately. **Power supply:** 230V 50Hz / 350 - 700mA.

**Sorgente:** High-power COB LED, CRI>80/90, MacAdam's2, 50,000h, L90 B10 a 35°C. **Ottica:** Ottica ad alta efficienza con distribuzione uniforme, policarbonato metallizzato tramite laccatura (spot, medium, wide) / Lenti in PMMA ad alta efficienza / Lenti acriliche metallizzate tramite laccatura (spot, medium, wide) ad alta efficienza con fascio regolabile. **Corpo:** Alluminio, verniciatura a polvere. **Alimentazione:** Alimentatore integrato ad alta efficienza on-off (FO) o dimmerabile (DALI-TD, Casambi). / Alcune versioni richiedono il montaggio del driver esterno - ordinare separatamente. **Alimentatore:** 230V 50Hz / 350 - 700mA.

**Svetlobni vir:** Visoko učinkovit COB LED modul, CRI>80/90, barvno odstopanje MacAdam's2, 50,000 h, L90 B10 na 35 °C. **Optika:** Visoko učinkovit metaliziran in lakiran polikarbonat z enakomerno porazdelitvijo svetlobnega snopa (ozek, srednji, široki svetlobni snop) / Visoko učinkovite PMMA optične leče (ozek, srednji, eliptični svetlobni snop) / Visoko učinkovite akrilne optične leče z nastavljivim kotom svetlobnega snopa. **Ohlajenje:** Aluminijsko, prašno barvano. **Napajalniki:** Integriran visoko učinkoviti LED konverter s konstantnim tokom (FO) ali regulacijskim zvišdom (DALI-TD, Casambi). / Nekateri verzije zahtevajo zunanji LED konverter - naročiti ločeno. **Napajanje:** 230 V 50 Hz / 350 - 700 mA.

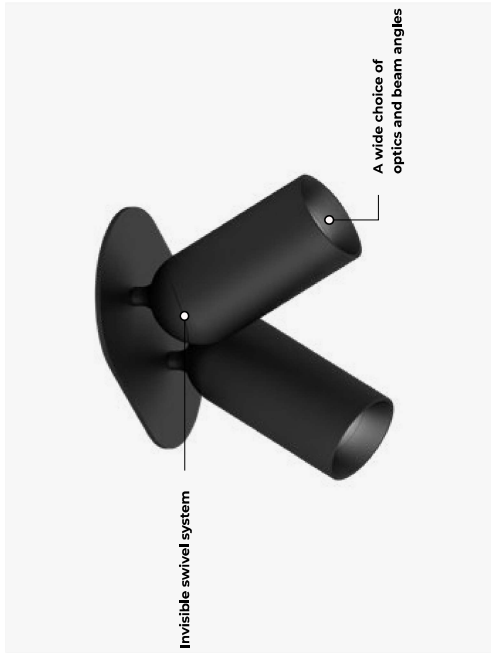

### MAIN FEATURES

## Innovative swivel system

Eye is unique for the way it can be rotated in all directions, while the swivel mechanism remains invisible. Three types of optics allow a wide range of use.



## Nothing is left to chance

All the details of this product communicate elegance, precision and perfection. Even when seen from the backside. In the track version the driver (FO, DALI or Casambi) is integrated in a track adapter.





INTRA-LIGHTING



# Vyko

## Ec(h)o friendly

No noise. No glare. No pollution.

You can finally forget about those unaesthetic acoustic ceilings. Here is Vyko, an advanced all-in-one product, able to create various scenarios and personalized micro ambiances. Therefore, it is a perfect pick for offices and large open spaces.

3D ecofriendly acoustic panels are made from 100% recyclable fibre, in order to guarantee an echo friendly acoustic performance. And above all things, it provides efficient homogeneous light distribution.

Non ammette rumori. Non abbaglia. Non inquina.

Puoi finalmente dire addio agli antiestetici controsoffitti insonorizzati. Ora c'è Vyko, un prodotto avanzato all-in-one, che sa creare nuovi scenari e microambienti personalizzati. La scelta perfetta per gli uffici e i grandi open space.

I pannelli acustici stampati in 3D sono prodotti con fibra riciclabile al 100%, e assicurano performance acustiche davvero echo-friendly. Ma soprattutto una distribuzione della luce efficace ed omogenea.

Brez hrupa. Brez bleščanja. Brez onesnaževanja.

Končno lahko pozabite na neestetske akustične stropove. Tukaj je Vyko, napreden izdelek, ki združuje vse v enem in lahko ustvari različne scenarije in posebno prilagojene mikroambiente. Zato je odlična izbira za pisarne ter velike odprte prostore.

3D okolju prijazne akustične plošče so izdelane iz 100% recikliranih vlaken, da bi zagotovile prijazno akustiko brez odmevanja. Predvsem pa Vyko zagotavlja učinkovito homogeno porazdelitev svetlobe.

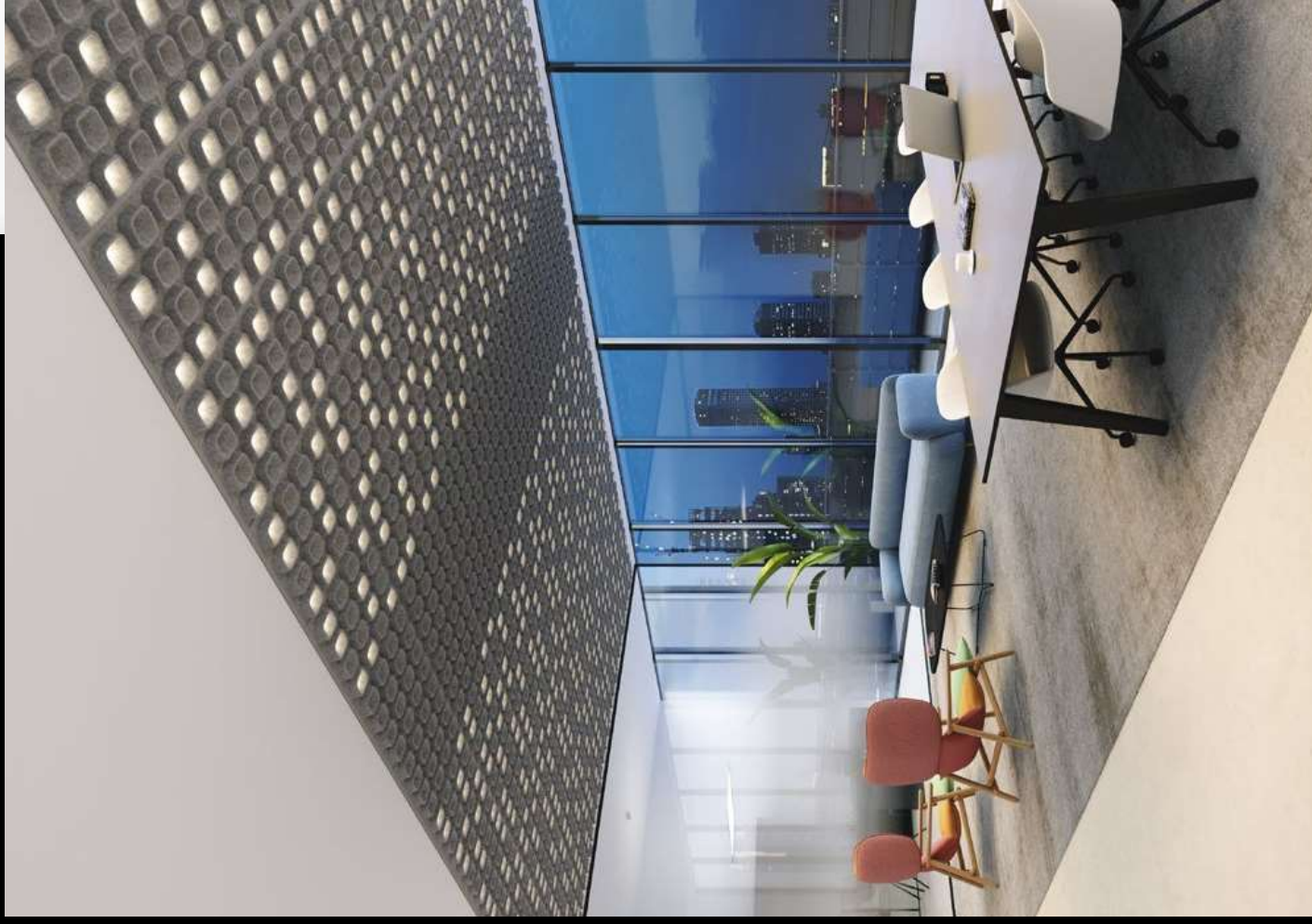













## It's a luminaire. It's a ceiling. It improves the acoustics.

Acoustic ceiling with light or vice-versa? No matter how you define it, it solves three problems at once: improves the acoustics, offers high quality illumination with absolutely no glare and replaces the ceiling.

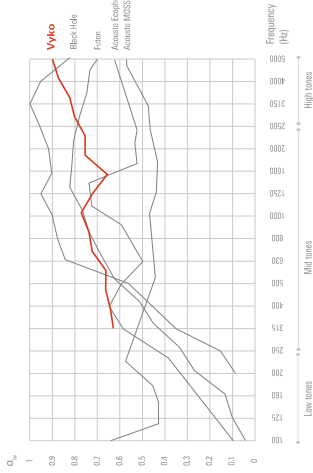

## Maximum acoustic comfort

Vyko enables effective soundproofing and sound absorbing in all areas with higher frequencies.



Made from  
**60%**  
recycled material  
(GR)

**End of life:  
100 % recyclable fibre**

**UGR  
<19**

**Glare control, high efficiency and visual comfort**

The 4 central modules are illuminated

### LFO VERSION

**Bartenbach LFO optic**

## No, it's not off.

Are you wondering where the light comes from? With the Bartenbach LFO optic, Vyko illuminates the space pleasantly with low glare and without seeing the light source. It looks like it is off, but the light will be there.



## Three shades of grey

It's just a matter of taste and the feeling you want to create. Choose brighter tones for a more fresh, open appearance and optically higher ceilings.

The Grey (GR) Acoustic panel is made from 60% recycled material, while Light Grey (LG) and Black (BL) are made of 28% recycled material.

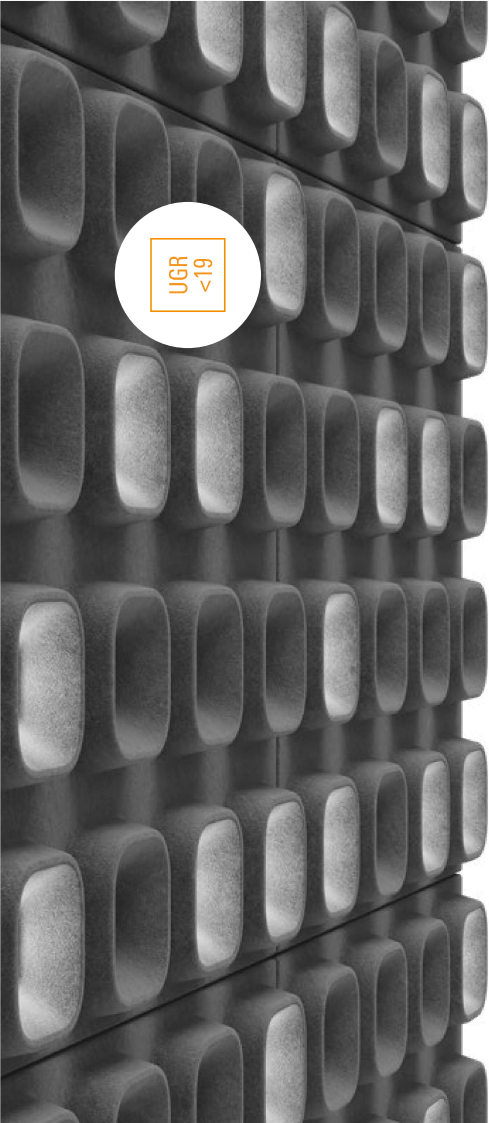

UGR <19

### Random patterns of light

No two layouts are the same, so each ceiling will be different, unique. Choose from different Deco versions or combine them with Vyko Dark.

#### DECO VERSION



Deco 6

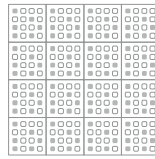

Deco 7

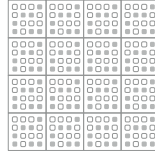

Deco 14

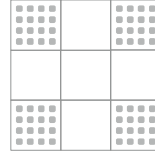

#### INSTALLATION TYPE



T bar lay in with standard modular ceiling elements



Click-in system with minimal distance between the panels and the ceiling

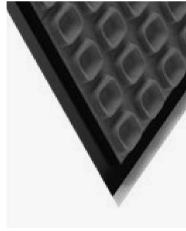

Suspended installation with side profile

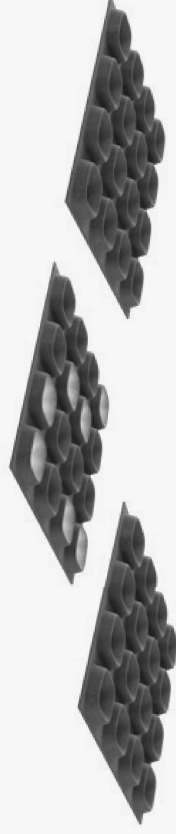

	LFO	DECO	DARK
<b>Glare control</b>	UGR<19	UGR<19	-
<b>Optics</b>	LFO 33°	Diffused	-
<b>Luminaire luminous flux</b>	660 lm	600 / 700 / 1600 lm	-
<b>N° of spots / panel</b>	4	6, 7, 16	-
<b>LED colour</b>	927, 930, 935, 940	927, 930, 935, 940	-
<b>Driver</b>	Casambi, DALI, FO	Casambi, DALI, FO	-
<b>Driver position</b>	Remote	Remote	-
<b>Material</b>	Thermoformed acoustic felt	Thermoformed acoustic felt	Thermoformed acoustic felt
<b>Sound absorbing surface</b>	0,6 m²	0,6 m²	0,6 m²

#### Dimensions

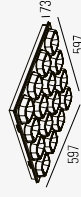

Colours:



GRO



CASAMBI



GRI



CASAMBI



CE



ENEC

**Light source:** High-power COB LED, CRI>90, Mac-Adams2, 50,000h; L90 B10 at 35°C. **Optic:** Acrylic glare-free LFO lens / Stained prismatic lens dome for uniform light distribution. **Body:** Thermoformed acoustic felt. **Control gear:** Integrated highly-efficient driver with fixed output (FO) or dimmable (DALI-TD, Casambi). **Power supply:** 230V/50Hz.

**Sorgente:** COB LED High-power, CRI>90, Mac-Adams2, 50,000h; L90 B10 a 35°C. **Optica:** Lente acrilica glare-free LFO / Lente prismatica satinata a cupola per una distribuzione uniforme della luce. **Corpo:** Feltro acustico termoformato. **Alimentazione:** Alimentatore ad alta efficienza on/off (FO) o dimmerabile (DALI-TD, Casambi) integrato. **Alimentatore:** 230V 50Hz.

**Svetlobni vir:** Visoko učinkovit COB LED modul, CRI>90, barvno odstopanje Mac-Adams2, 50,000 h, L90 B10 na 35 °C. **Optika:** Akrilna LFO leča brez bleščanja / Satinirana prizmatična kupola za enakomerno osvetlitev. **Ohišje:** Termoformirani akustični filis. **Napajalniki:** Integriran visoko učinkoviti LED konverter s konstantnim tokom (FO) ali regulacijskim izhodom (DALI-TD, Casambi). **Napajanje:** 230 V 50 Hz.

CONTACT US

# Let's work together

Collaboration is the key to success. We have all you need: innovative high-quality products, knowLEDge, immense passion, more than 30-year tradition and experience, excellent staff, outstanding references and great partners. Let's create the future together and make it visible. All visible.

[www.intra-lighting.com](http://www.intra-lighting.com)

## Headquarters

Intra lighting d.o.o.  
Vrtojbenska cesta 50  
5280 Šempeter pri Gorici  
Slovenia

T: +386 5 398 44 00  
[info@intra-lighting.com](mailto:info@intra-lighting.com)

Follow us on



Find us on



Sales point

## Offices

**Benelux**  
**Intra lighting Benelux B.V.**  
Gildenstraat 2b  
4143 HS Leerdam

T: +31 345 623 678  
E: [sales@intra-lighting.nl](mailto:sales@intra-lighting.nl)

**Bosna and Herzegovina**

**Intra lighting d.o.o.**

Hasana Birkica 30  
71000 Sarajevo

T: +387 33 642 841  
E: [info@intra-lighting.com](mailto:info@intra-lighting.com)

**Croatia**

**Intra lighting d.o.o.**

Ulica grada Vukovara 2684  
10000 Zagreb

T: +385 1 6389 141  
E: [info@intra-lighting.com](mailto:info@intra-lighting.com)

**Italy**

**Intra lighting S.r.l.**

Via Adelaide Bono Carroli 30  
20127 Milano

T: +39 02 9176 1234 / 42  
E: [info@intra-lighting.com](mailto:info@intra-lighting.com)

**North America**

**Intra lighting US, LLC**

227 W 29th Street, 12th Floor  
New York, NY 10001

T: 215-918-4199  
M: 215-388-1800  
E: [info.us@intra-lighting.com](mailto:info.us@intra-lighting.com)

**United Arab Emirates**

**Intra lighting Middle East**

Office SWB 241, Building SWB  
Dubai Airport Freezone, Dubai

T: +971 42602089  
E: [info@intra-lighting.com](mailto:info@intra-lighting.com)

**Slovenia**

**Intra lighting d.o.o.**

BTC, PTC Diamant  
Letalska 5  
1000 Ljubljana

T: +386 1 547 65 30  
E: [info@intra-lighting.com](mailto:info@intra-lighting.com)

**Serbia**

**Intra lighting d.o.o. Beograd**

Omladinskih brigada 90B  
Airport City  
11070 Novi Beograd

T: +381 11 269 8 476  
E: [info@intra-lighting.com](mailto:info@intra-lighting.com)



## Imprint

Design: Intra lighting Text: Intra lighting & J&S Aladin

Intra lighting has the right to change, at any time, the technical aspects of its products or product data without prior notice. The data in this brochure is provided in good faith and only for your information. All information is without engagement, replacing preceding information and can always be modified. No part of this brochure may be copied without the written authorization of Intra lighting.

03/2023

© Intra lighting d.o.o.



